

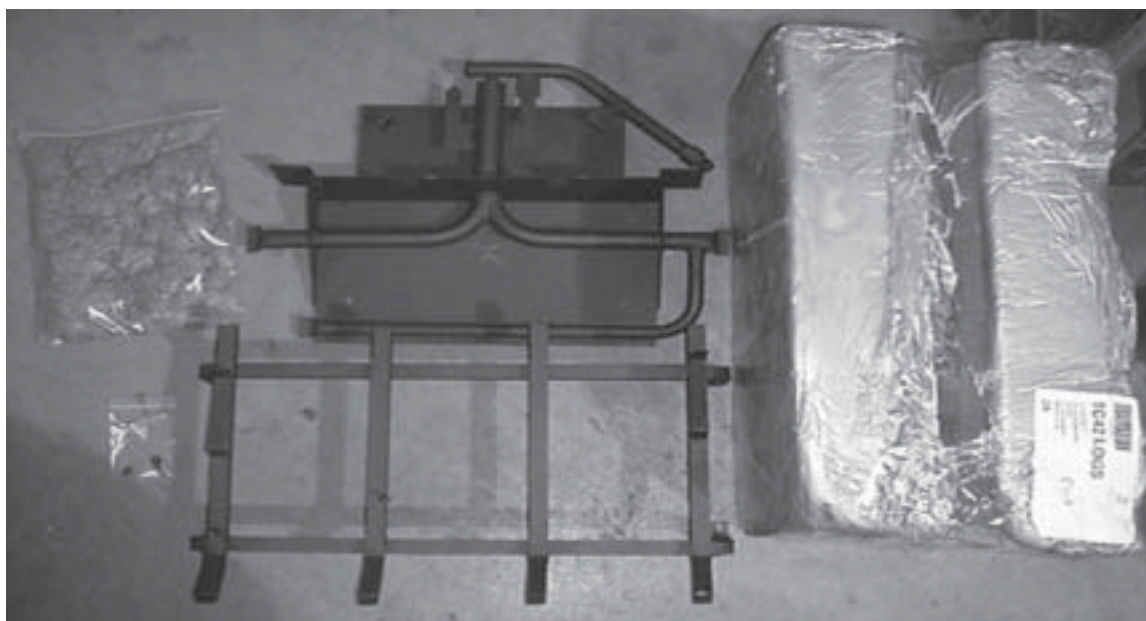


TOWN & COUNTRY
FIREPLACES™

CHALET BURNER KIT TC42.NG01

PACKAGE CONTENTS:

- | | | |
|--------------------|--------|-------------|
| • BURNER ASSEMBLY | PART # | TC42.908501 |
| • LOG GRATE | PART # | TC42.9081 |
| • TC42 LOGS | PART # | 5098.31061 |
| • EMBER MATERIAL | PART # | 5096.981.B |
| • HARDWARE PACKAGE | PART # | TC36.NGHDWR |



These instructions are supplementary to the Installation and Operating Instructions supplied with the fireplace and should be kept together. Refer to the Installation and Operating Instructions for proper gas supply, safety requirements and operating instructions.

**IMPORTANT: THESE INSTRUCTIONS
ARE TO REMAIN WITH THE
APPLIANCE INSTRUCTIONS**



CONTROL BOX RELOCATION

The gas control system is housed in a control box remote of the fireplace. Flexible conduits attach the control box to the fireplace and house all the plumbing and wiring to the burner.

The control box is shipped inside the firebox and needs to be installed. Although the control box may be installed on the right or left side, the fireplace is assembled at the factory to accept the control box from the right hand side.

If installing on the left hand side, the casing and firebox inlet covers must first be removed and reinstalled on the opposite side of the unit. The manifold will also need to be repositioned once the burner is installed. This is done by removing two retaining screws, turning the manifold over and re-attaching. See Fig. #3.

DEFAULT INSTALLATION

- 1) Insert the inlet box into the opening at the base of the right hand side of the unit as shown in fig # 1 taking care not to damage pilot, plumbing or wires.
- 2) Install 4 screws from the inside of the firebox to secure the inlet box to the firebox.
- 3) Install Panel Set (Refer to "Firebox Panels Installation" in the Installation and Operating Instructions manual)

Fig. # 1

INLET BOX



INSERT CONTROL ASSEMBLY

Fig. # 2



INSTALL SCREWS TO SECURE INLET BOX

A panel set must be installed prior to the installation of the burner/grate assembly. See Installation and Operating Instructions manual for details.

Fig. # 3



REPOSITION MANIFOLD

BURNER/GRATE INSTALLATION

- 1) Attach the burner assembly to the floor of the firebox with two screws . See Fig. # 4.
- 2) Attach pilot bracket to burner assembly using 2 #8 x 5/16 type F. See Fig. # 5.
- 3) Connect flex gas line to the manifold assembly and ensure the connection is gas tight. See Fig. # 5.
- 4) Position the grate in the slots of the burner tray and attach to the floor with two screws through holes located behind the front legs of the grate. See Fig. # 6.

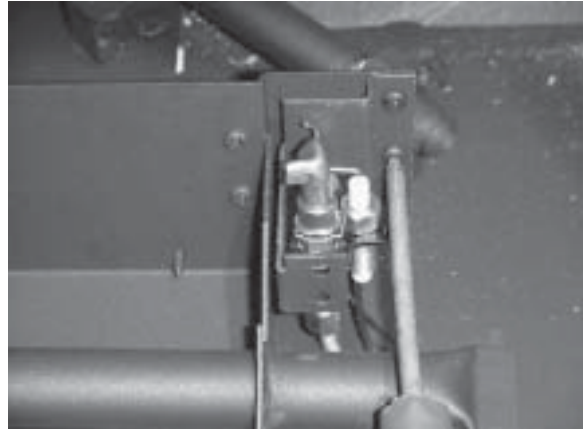
Fig. # 4



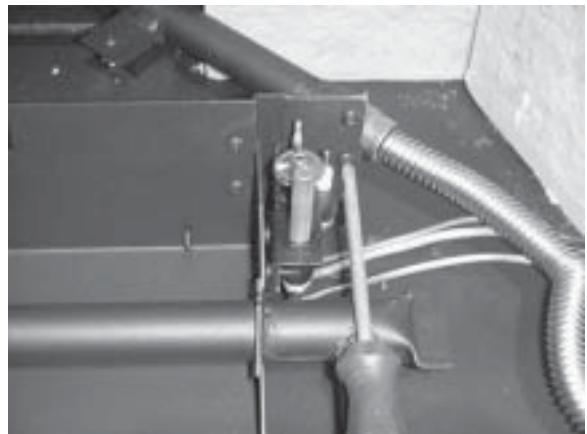
BURNER TRAY INSTALLATION

Fig. # 5

ELECTRONIC PILOT

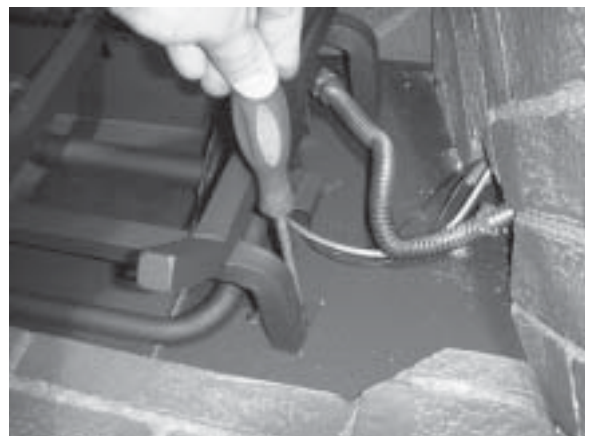


MILLIVOLT PILOT



**ATTACH PILOT BRACKET TO
BURNER ASSEMBLY**

Fig. # 6

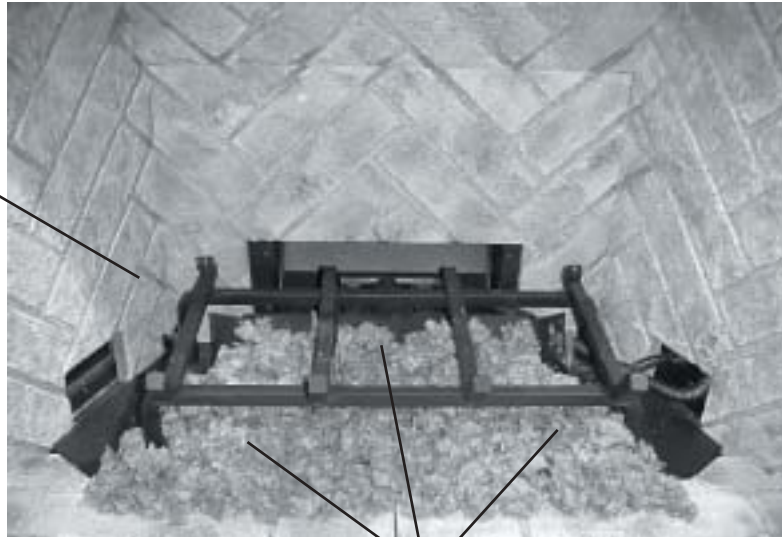


GRATE INSTALLATION

Fig. # 7

Ember Material Placement

LOG
GRATE



GLOWING EMBERS

EMBER MATERIAL

A large bag of ember material is shipped with the fireplace and needs to be installed to ensure optimum performance and flame appearance.

Pull apart the material into ember size pieces (approximately 1" squares) and gently place them into the burner pan. Do not compress, leave it loose for best performance. Fill the burner pan level with the top of the pan at rear, and gradually sloping forward down to the firebox floor at the front, covering both burner tubes. Place remaining ember material outside of the burner pan as desired to cover-up gas lines and brackets.

Note: Ember material placement and amount will affect flame appearance. More ember material results in lower flame height. Add or remove as needed until desired flame affect. Reduce the amount used on Propane models, as too much will create soot.

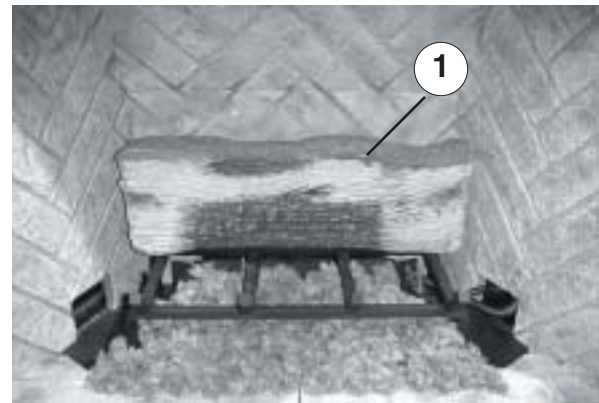
LOG SET ASSEMBLY

The logs are packaged in a foam pack inside the box, are fragile, and should be handled with care. Unpack and inspect log set. There should be a total of 6 logs. Gas plumbing and vent connections should be completed before proceeding. Position the logs as indicated by the following pictures. Place the rear log back against the tabs located at the back of the grate. Place left log as pictured, engaging the pins with corresponding holes on the underside of the log. Install the right log into the grate and pull it forward into position as shown. Install the middle log into the space between the left log and the front of the grate as shown. Place the two remaining small logs on the floor of the firebox as shown.

Fig. # 8

Step 1

Rear Log Placement



Step 2

Left Log Placement

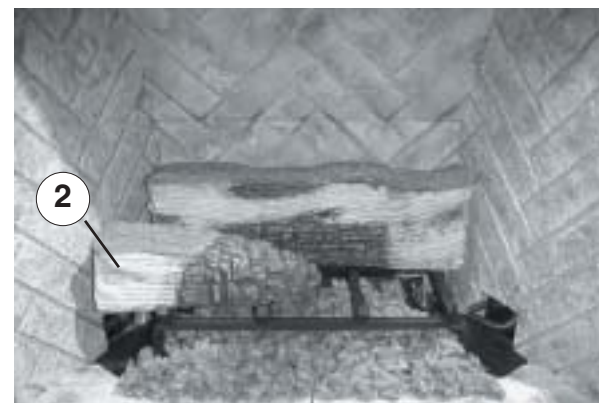


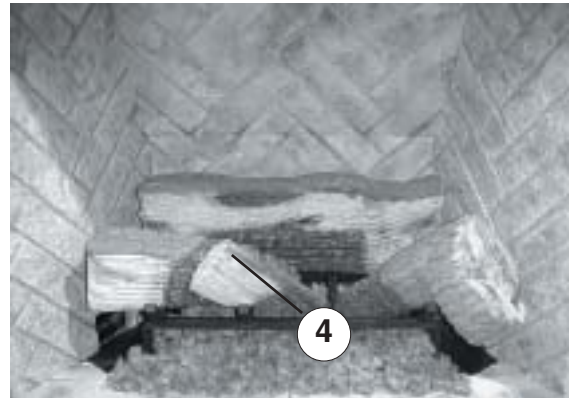
Fig. #9

Step 3
Right Log Placement

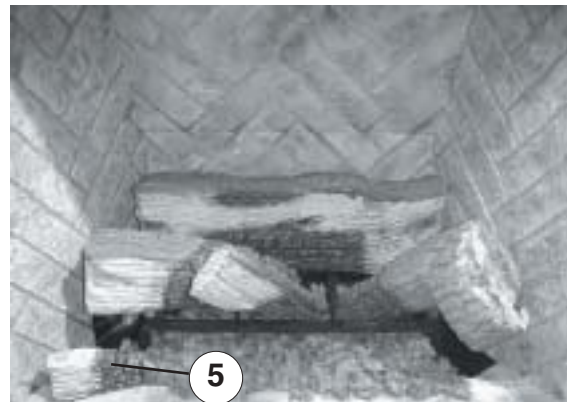


Fig. #10

Step 4
Middle Log Placement

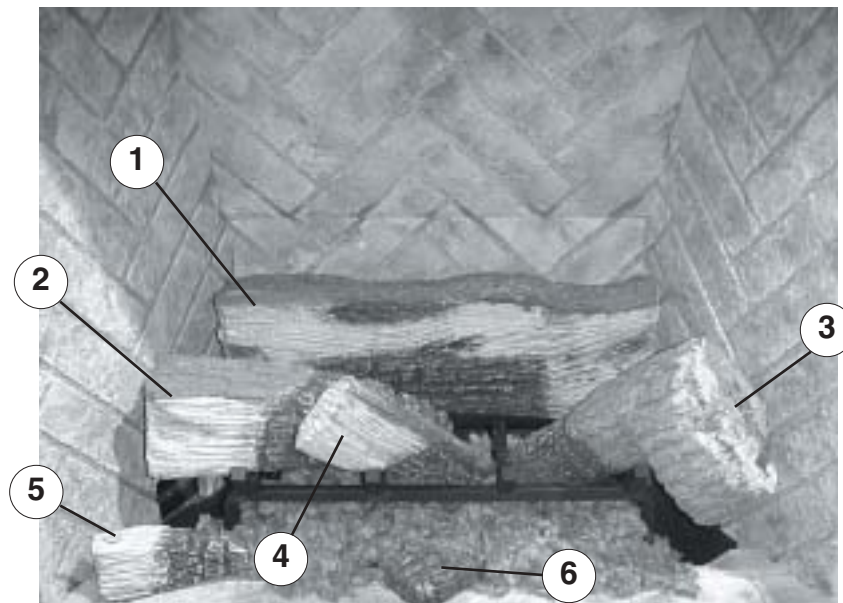


Step 5
Bottom Left Log Placement



Note: Improper placement of logs may cause sooting on internal parts and glass. The logs may need to be repositioned slightly to avoid excessive flame impingement.

Fig. #11



BURNER FLAME ADJUSTMENT

The air shutter on the burner tube controls the primary combustion air to the gas burner and is pre-set closed at the factory for natural gas fuel. Some adjustment may be necessary to obtain desired flame and to eliminate carbon deposits. Evaluate flame appearance after the fireplace has reached operating temperature. See Fig. #13 for proper flame pattern.

Open primary air shutter if the logs, glass, and firebox have carbon accumulation and/or the flames are long, dark and stringy. The shutter may also be opened to enhance the Ember Material glow and lessen the flame height.

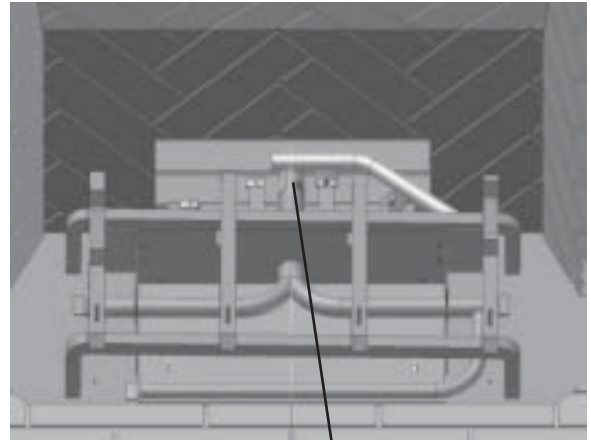
Caution: Burner area may be hot!

Turn off the fireplace and allow the unit to cool before proceeding.

To Adjust: (See Fig. # 12)

- 1) Open and remove window frame and set aside. See "Window Frame Removal" section found in the Installation and Operating Instructions manual.
- 2) Remove the log set and set aside.
- 3) Loosen the screw in the Primary Air Shutter.
- 4) Rotate the shutter to increase or decrease the amount of primary air.

Fig. # 12



PRIMARY AIR SHUTTER

The flame should be just orange and "lazy". It should NEVER be set to create sooting on internal parts and glass.

Fig. # 13

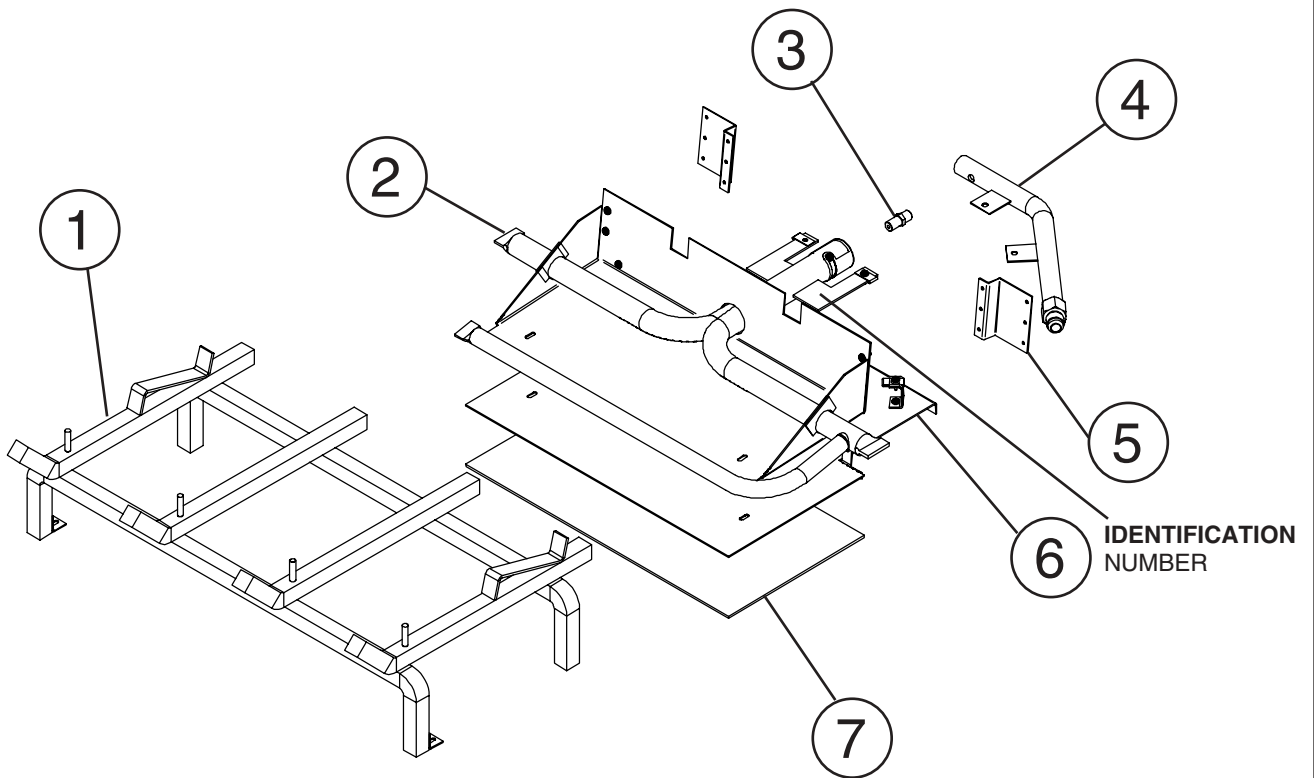


HERRINGBONE PANEL SET WITH OPTIONAL ANDIRONS SHOWN

REPLACEMENT PARTS

ITEM.....	DESCRIPTION.....	PART NO.	DESCRIPTION	PART NO.
1.....	LOG GRATE	TC42.9081	LOG SET, COMPLETE.....	5098.31061
2.....	BURNER TRAY	TC42.908501WLD	REAR, #1 (shown in fig.#11)	5098.3101
3.....	ORIFICE, NG	5022.12	LEFT, #2 (shown in fig.#11)	5098.3102
.....	ORIFICE, LP	5021.31	RIGHT, #3 (shown in fig.#11).....	5098.3103
4.....	MANIFOLD.....	TC42.9088.1WLD	MIDDLE, #4 (shown in fig.#11).....	5098.3104
5.....	PILOT SHIELD.....	9085.8	BOTTOM LEFT, #5 (shown in fig.#11).....	5098.3105
6.....	BURNER TRAY SUPPORT SHIELD	9089.01	BOTTOM CENTRE, #6 (shown in fig.#11) .	5098.3106
7.....	BURNER TRAY SHIELD GASKET.....	9047			

Fig. # 14





TOWN & COUNTRY
FIREPLACES™

www.townandcountryfireplaces.net

2975 Allenby Rd., Duncan, BC V9L 6V8

Phone: 1-888-223-0088