

INSTALLER: Leave this manual with the appliance.

CONSUMER: Retain this manual for future reference.

These instructions are supplementary to the Installation and Operating Instructions supplied with the fireplace and should be kept together. Refer to the Installation and Operating Instructions for proper gas supply, safety requirements and operating instructions

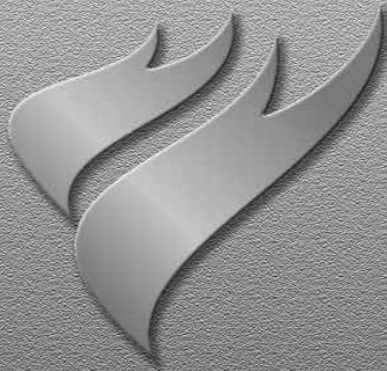

TOWN & COUNTRY
L U X U R Y F I R E P L A C E S

TC42 CHALET BURNER KIT INSTALLATION INSTRUCTIONS



**PART# 22150036
For TC42 Series D
Fireplaces**



Visit www.townandcountryfireplaces.net for the most recent version of this manual

Contents of Package

- BURNER ASSEMBLY
- LOG GRATE
- LOGS
- 2 BAGS EMBER MATERIAL
- HARDWARE PACKAGE (Not Shown)

If this fireplace is to be used on Propane please convert prior to installation. See pages 9 – 11.

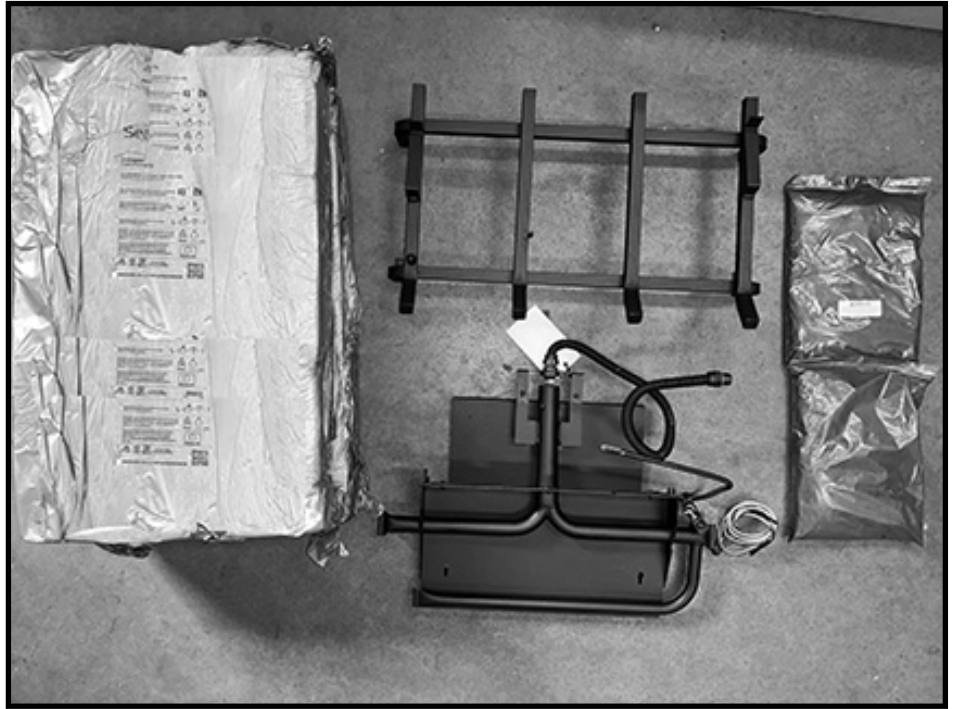

Figure 1: Package contents.

Burner Installation

1. Place the keyhole slots in the burner (Figure 2) over the two screws located in the firebox base (Figure 3).
2. Slide the burner back to engage the screws in the small part of the keyhole slot and tighten screws.
3. Remove access cover from side of firebox (Figure 4).



Figure 2: Attaching burner to floor of fireplace.

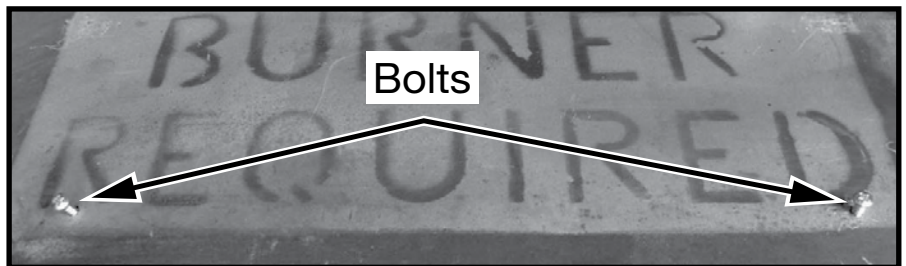
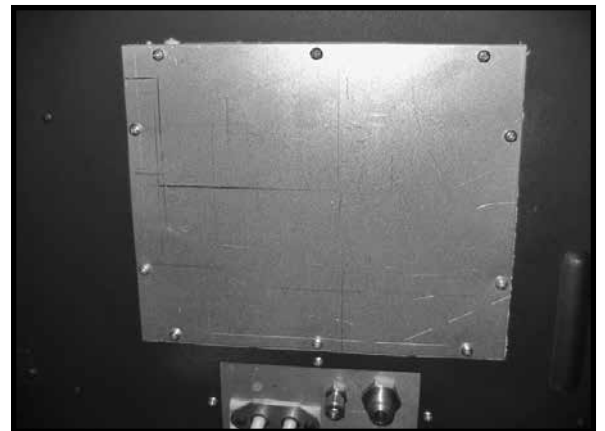

Figure 3: Bolts for burner.

Figure 4: Control center access cover.



Burner/ Grate Installation

4. Attach the manifold gas and pilot supply tubes to the bulk head fitting and tighten (Figure 5).

Ensure that all connections are gas tight.

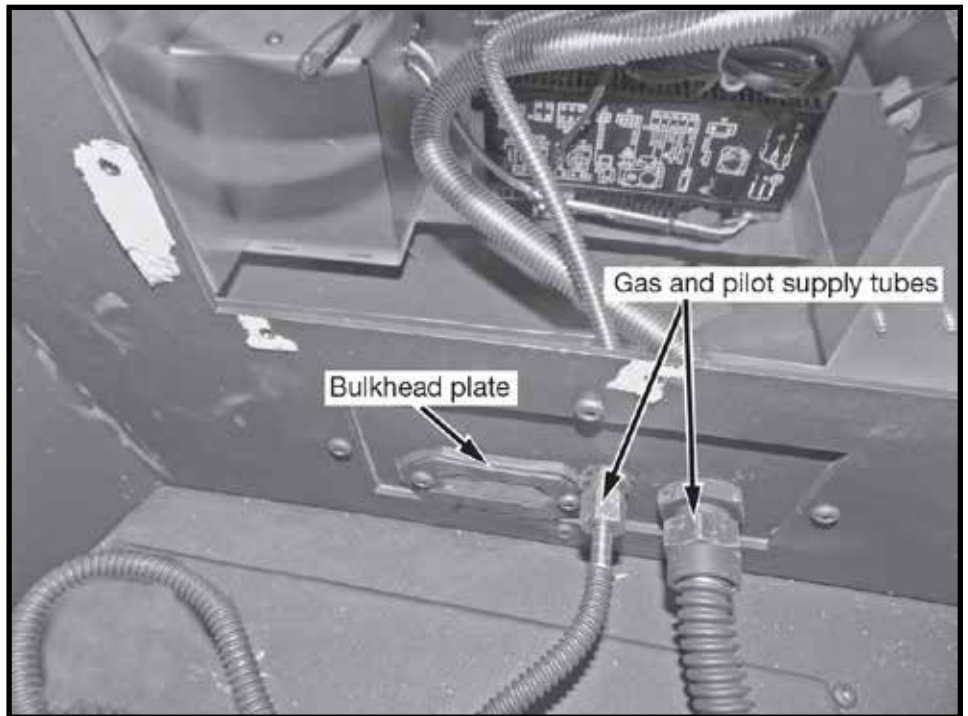

Figure 5: Gas and pilot supply tubes.

5. Feed the ignition and sensor wires through the bulkhead plate (Figure 6) to the interface.

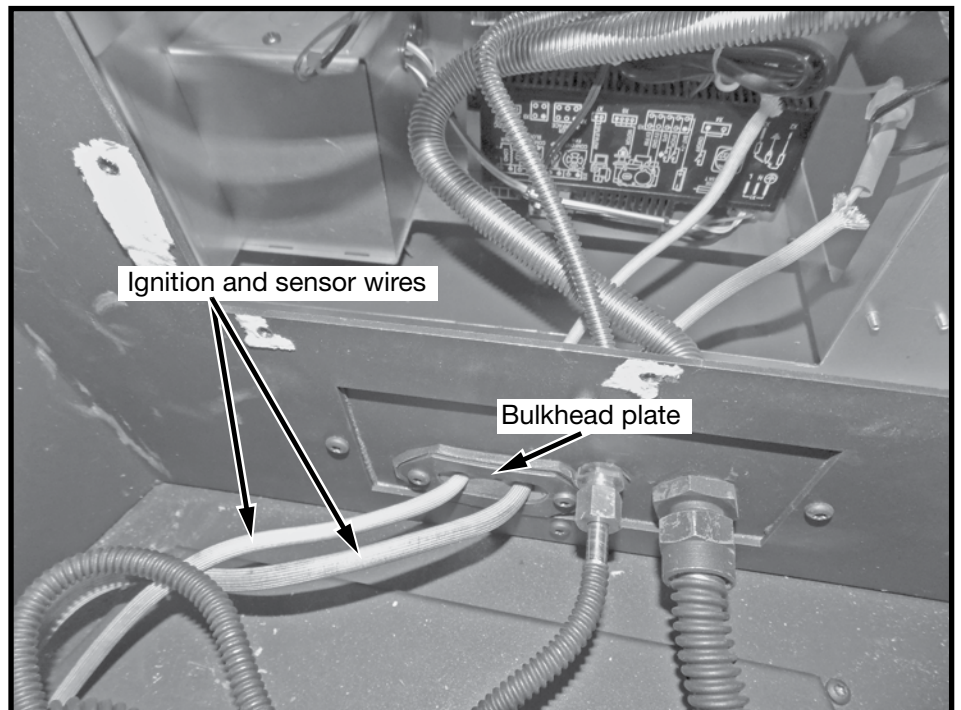

Figure 6: Ignition and sensor wires routing.

6. Attach the ignition and sensor wires to the module (Figure 7).

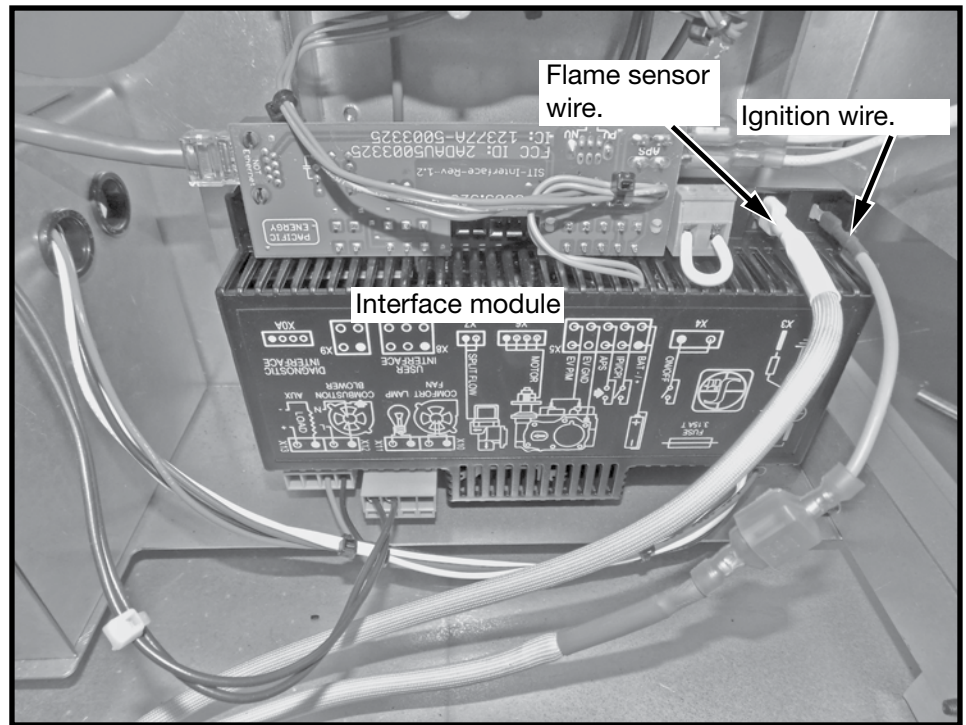

Figure 7: Interface module.

7. Replace the access cover (Figure 4).

A panel set must now be installed. See Installation and Operating Instructions manual for details.

8. Position the slots of the grate securing brackets over the holes in the floor shield and secure with the two screws (Figure 8).



Figure 8: Securing the grate.

Ember Material

A large bag of glowing ember material is supplied with the burner kit and needs to be installed on the burner to ensure optimum performance and flame appearance.

1. Pull apart the material into ember size pieces (approximately 1" squares) and gently place them into the burner pan. Do not compress, leave them loose for best performance.
2. Fill the burner pan level with the top of the pan at rear, and gradually sloping forward down to the firebox floor at the front, covering both burner tubes.
3. Place remaining ember material outside of the burner pan as desired to cover-up gas lines and brackets.

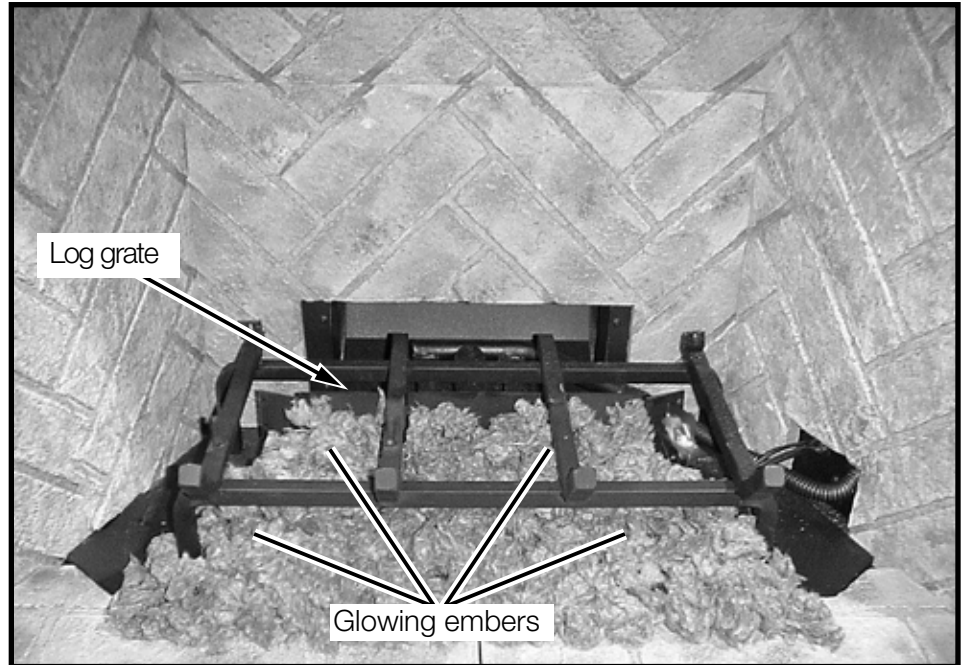

Figure 9: Ember material placement.

Note: Ember material placement and amount will affect flame appearance. More ember material results in lower flame height. Add or remove as needed until desired flame affect.

Log Set Assembly

Gas plumbing and vent connections should be completed before proceeding.

The logs are fragile and should be handled with care. Unpack and inspect log set. There should be a total of 7 logs.

Position the logs as indicated by the following pictures. Place the rear log back against the tabs located at the back of the grate. (Figure 10).

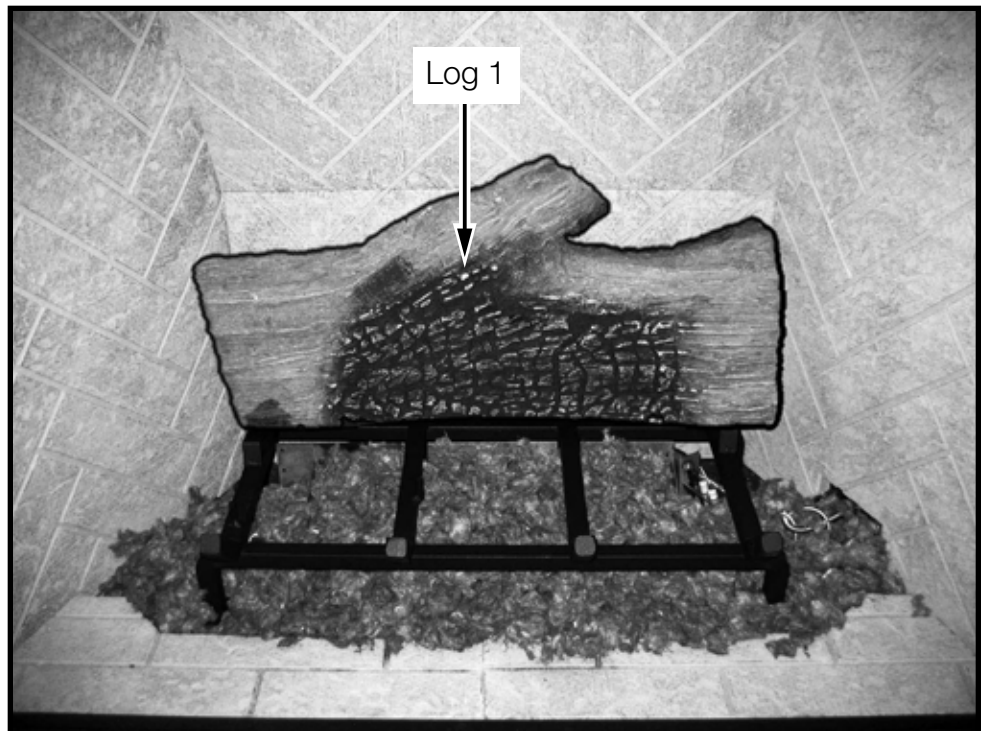

Figure 10: Log 1 placement.

Place log 2 as pictured, engaging the pins with corresponding holes on the underside of the log.

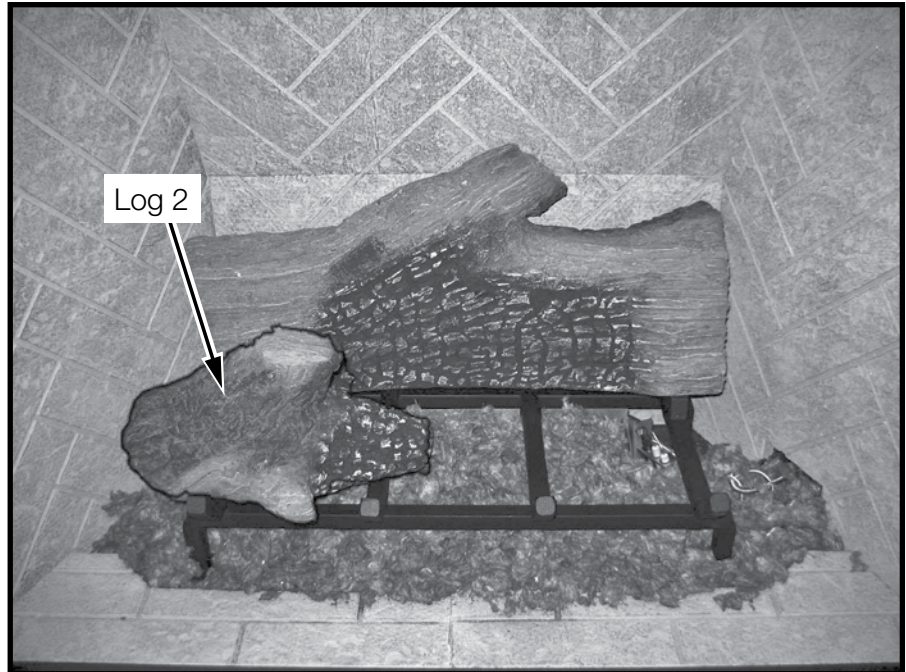

Figure 11: Log 2 placement.

Install log 3 into the grate and pull it forward into position as shown.

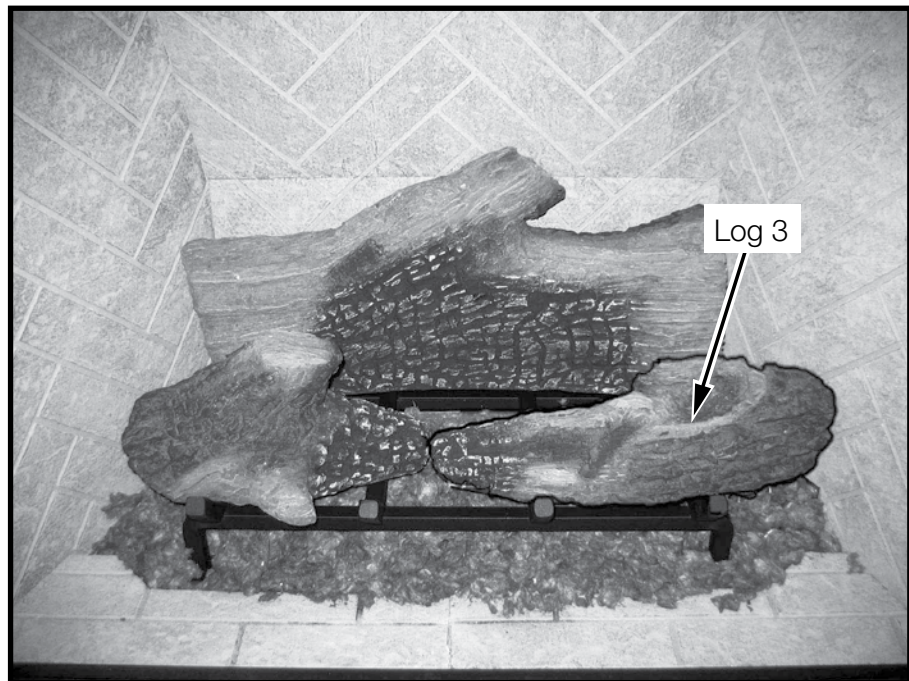

Figure 12: Log 3 placement.



Figure 13: Log 4 placement.

Place the four remaining small logs on the floor of the firebox in the positions and order as shown.

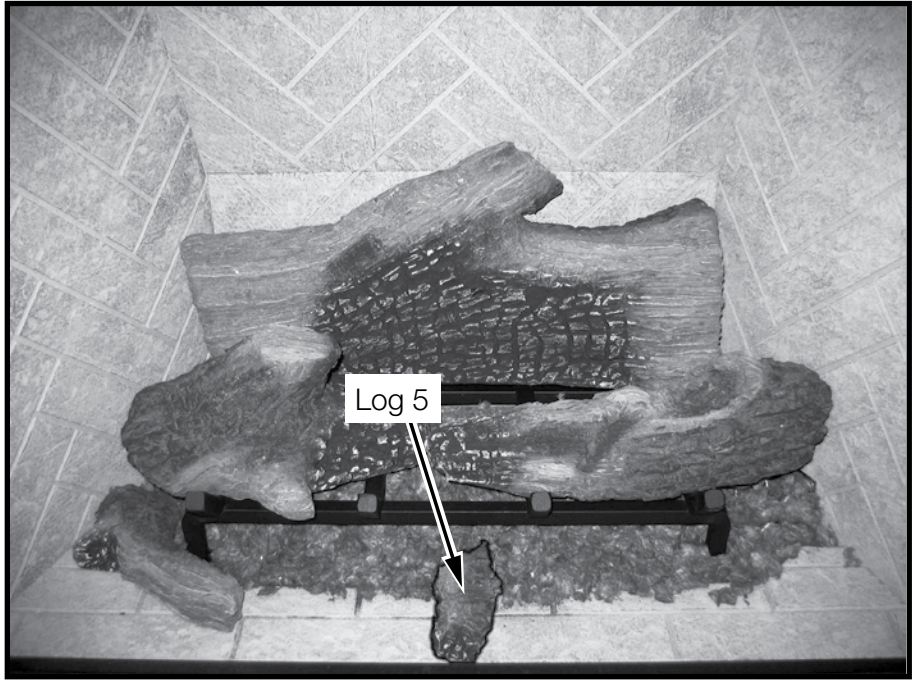

Figure 14: Log 5 placement.

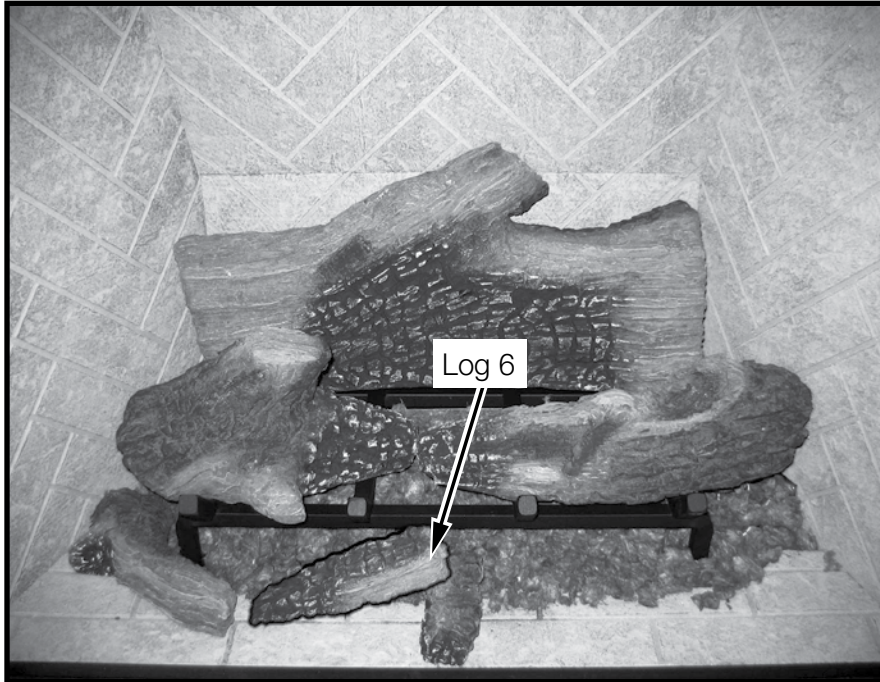

Figure 15: Log 6 placement.

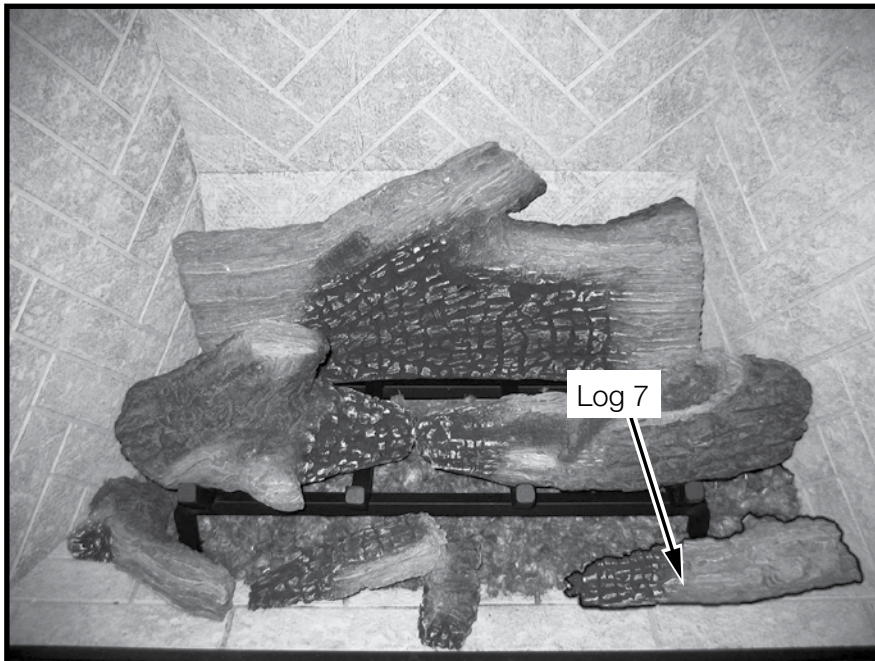

Figure 16: Log 7 placement.

Note: Improper placement of logs will cause sooting on internal parts and glass.

Propane Conversion

Note: The propane conversion kit is not included with the burner kit. The conversion kit is an option which must be ordered separately

If the unit is to be used with propane gas, convert the fireplace from natural gas as follows using the components supplied with this burner kit.

Note: Factory supplied components must be used to ensure correct input. After conversion confirm proper manifold pressure.

WARNING

This conversion kit shall be installed by a qualified service agency in accordance with the manufacturer's instructions and all applicable codes and requirements of the authority having jurisdiction.

If the information in these instructions is not followed exactly, a fire, explosion or production of carbon monoxide may result causing property damage, personal injury or loss of life.

The qualified service agency is responsible for the proper installation of this kit.

The installation is not proper and complete until the operation of the converted appliance is checked as specified in the manufacturer's instructions supplied with the kit.

CAUTION

The gas supply and electrical power must be shut off before proceeding with the conversion.

1. Ensure the burner, pilot and gas supply are turned off, and the appliance has cooled.
2. Remove the two screws securing the manifold assembly to the burner (Figure 17).
3. Remove the manifold assembly from the burner (Figure 18).

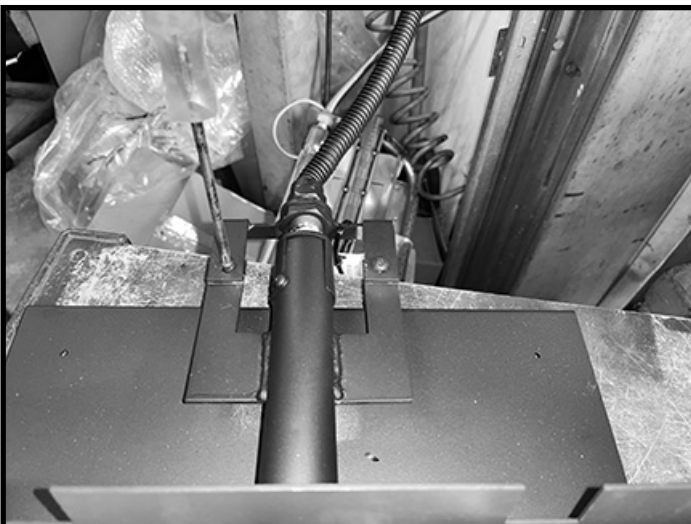

Figure 17: Unscrewing manifold from the burner.

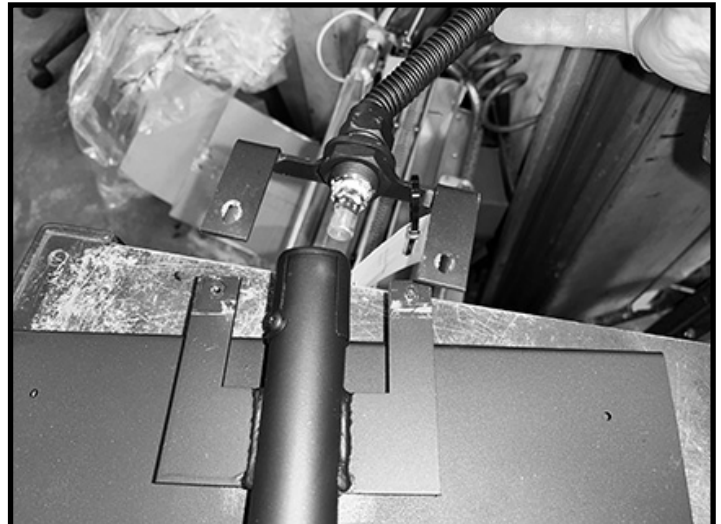

Figure 18: Orifice exposed.

4. With a ½” wrench remove the natural gas orifice (Figure 19).
5. Install propane orifice (marked “LE”) (Figure 20).
6. Fully open the primary air shutter.



Figure 19: Removing orifice.



Figure 20: Orifice.

7. Reinstall the manifold assembly.
8. With a 7/16” wrench loosen the pilot head on the pilot assembly by a half-turn (Figure 21)
9. Slide the pilot adjustment band over and ensure that the hole in the orifice band is showing. Figure 22 shows the pilot band in natural gas position. Figure 23 shows the pilot band in propane position.



Figure 21: Loosening the pilot head.

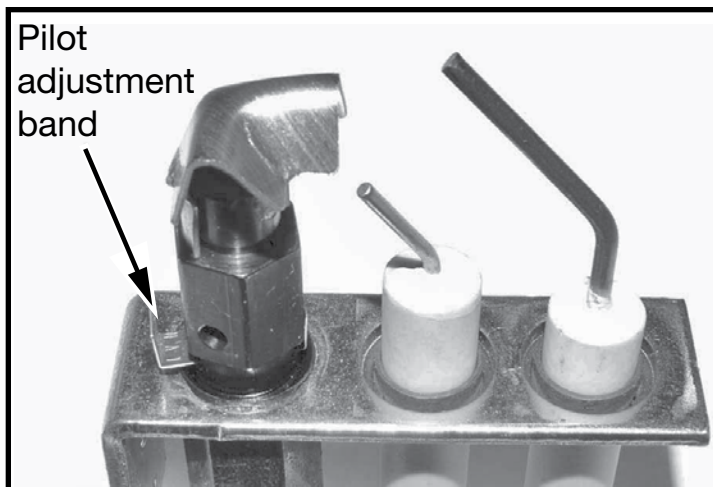

Figure 22: Pilot band in natural gas position.

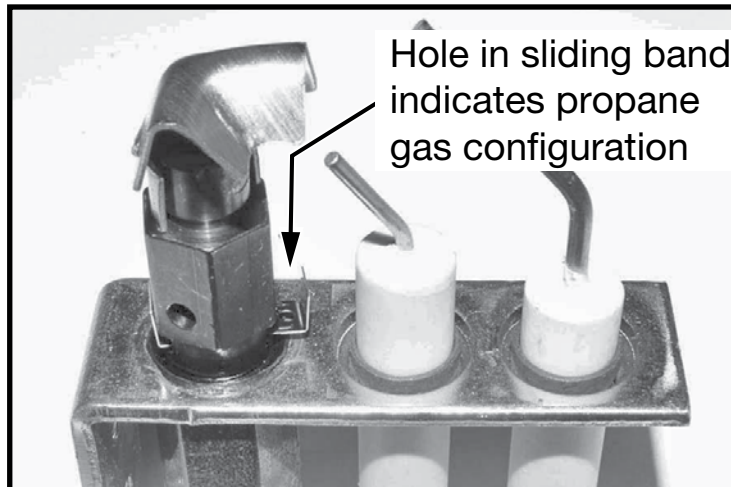

Figure 23: Pilot band in propane gas position.

10. Open the air shutter by following the steps in the Burner Flame Adjustment on page 12.
11. Complete the gas valve conversion from natural gas to propane gas according to the instructions included in the SIT propane gas conversion kit.
12. Fill in the conversion label Figure 24 . Peel off the protective backing and apply the conversion label directly over the gas specifications on the rating label. Rating label can be found on a metal plate stored on the left hand side of the fireplace, behind the decorative trim.

This appliance was converted to propane gas	
Kit Number	PACIFIC ENERGY
dd / mm / yy	5052.52001-B
Company	conversion a été correctement faite.
Address	responsabilité que cette ci-dessus accepte la l'entreprise désignée
The above accepts the responsibility that this conversion has been properly performed.	Adresse
5052.52001-B	Firme
PACIFIC ENERGY	a / m / j
Cet appareil a été converti en gaz propane	Numero d'assemblage

Figure 24: Propane conversion label.

For complete valve installation instructions, refer to the instruction book included in the SIT conversion kit.

Burner Flame Adjustment

The air shutter on the burner tube controls the primary combustion air to the gas burner and is preset at the factory for natural gas fuel. Some adjustment may be necessary to obtain desired flame and to eliminate carbon deposits. Evaluate flame appearance after the fireplace has reached operating temperature.

Open primary air shutter if the logs, glass, and firebox have carbon accumulation and / or the flames are long, dark and stringy. The shutter may also be opened to enhance the Ember Material glow and lessen the flame height. See Figure 25 for an example of a proper looking flame. The flame should be just orange and "lazy". It should NEVER be set to create sooting on internal parts and glass.

For Propane, start with the air shutter fully open and adjust to decrease air if needed.

Caution: Burner area may be hot! Turn off the fireplace and allow the unit to cool before proceeding.



Figure 25: Desirable flame appearance.

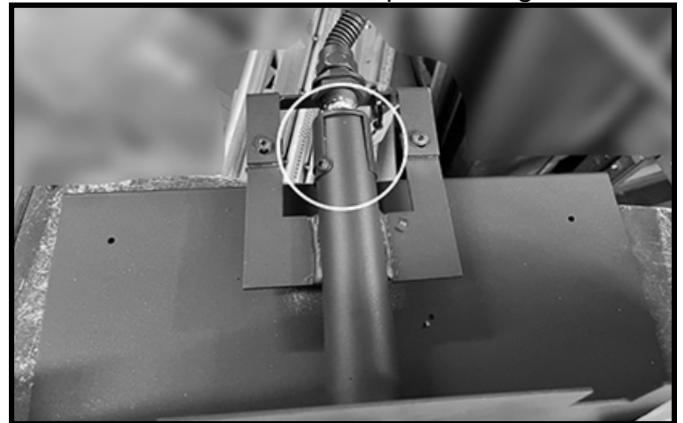

Figure 26: Air shutter location.

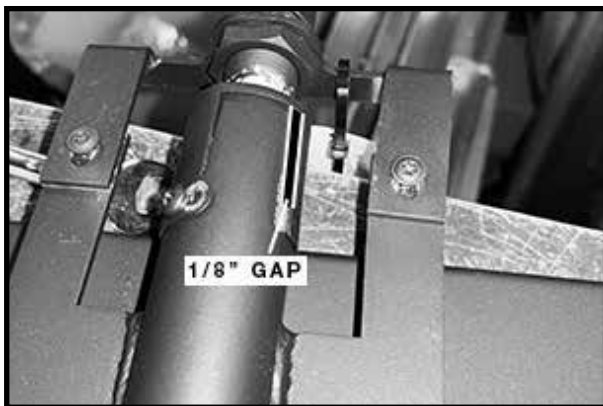

Figure 27: Air shutter in natural gas position.



Figure 28: Shutter set for propane.

To Adjust:

1. Open and remove window frame and set aside. See "Window Frame Removal" section found in the Installation and Operating Instructions manual.
2. Remove the log set and set aside.
3. Locate and loosen the air shutter adjustment screw (Figure 28).
4. Rotate the shutter to increase or decrease the air intake depending on type of gas being used.
5. Tighten adjustment screw and reassemble in log set.

Replacement Parts

(WHEN ORDERING, INCLUDE PART NUMBER WITH DESCRIPTION)

ITEM	DESCRIPTION	PART NO.	ITEM	DESCRIPTION	PART NO.
#1.....	BURNER ASSEMBLY	22150036	#5.....	MAIN SUPPLY TUBE (FLEX).....	80001888
#2.....	7 PCS LOG SET (TC42).....	80000533	#6.....	PILOT TUBE (FLEX)	80001625
#3.....	ORIFICE, NATURAL GAS (4.09 mm).....	80001694	#7.....	PROPANE CONVERSION KIT	22180008 *
#4.....	PILOT ASSEMBLY	80000522			

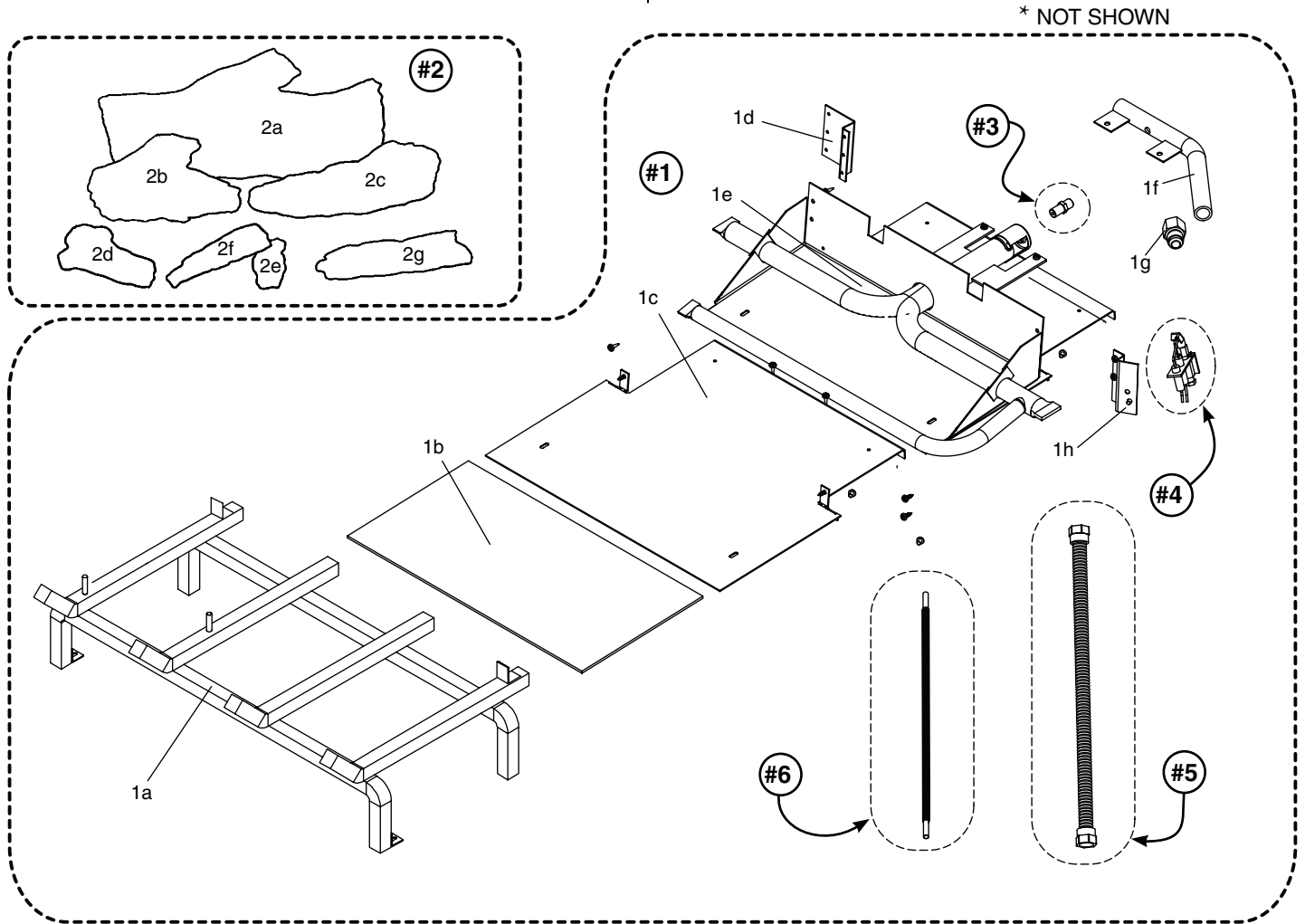

KIT CONTENTS:

- | | | |
|--|--|--|
| #1..... BURNER ASSEMBLY | #2..... 7 PCS LOG SET EMBER MATERIAL (Not shown) | #3..... ORIFICE, NATURAL GAS (4.09 mm) |
| 1a.....GRATE | 2a.....LOG #1 | #4..... PILOT ASSEMBLY, CONVERTIBLE |
| 1b.....BURNER INSULATION | 2b.....LOG #2 | #5..... MAIN SUPPLY TUBE (FLEX) |
| 1c.....BURNER TRAY SUPPORT SHIELD | 2c.....LOG #3 | #6..... PILOT TUBE (FLEX) |
| 1d.....PILOT SHIELD | 2d.....LOG #4 | #7..... PROPANE CONVERSION KIT (Not shown) |
| 1e.....TC42.NG01 BURNER WELD | 2e.....LOG #5 | |
| 1f.....MANIFOLD | 2f.....LOG #6 | |
| 1g.....1/2 PIPE TO 1/2 TUBE CONNECTION | 2g.....LOG #7 | |
| 1h.....PILOT BRACKET | | |



© 2019 Copyright Pacific Energy Fireplace Products LTD

Reproduction, adaptation, or translation
without prior written permission is prohibited,
except as allowed under the copyright laws.



For technical support, please contact your retailer.

**www.townandcountryfireplaces.net
2975 Allenby Rd., Duncan, BC V9L 6V8**