

**INSTALLER: Leave this manual with the appliance.
CONSUMER: Retain this manual for future reference.**

These instructions are supplementary to the Installation and Operating Instructions supplied with the fireplace and should be kept together. Refer to the Installation and Operating Instructions for proper gas supply, safety requirements and operating instructions.



TOWN & COUNTRY
L U X U R Y F I R E P L A C E S

TC30 TRANQUILITY BURNER KIT INSTRUCTIONS



**SKU# 22150002
For TC30 Series D
Fireplaces**



Visit www.townandcountryfireplaces.net for the most recent version of this manual

Contents of Package

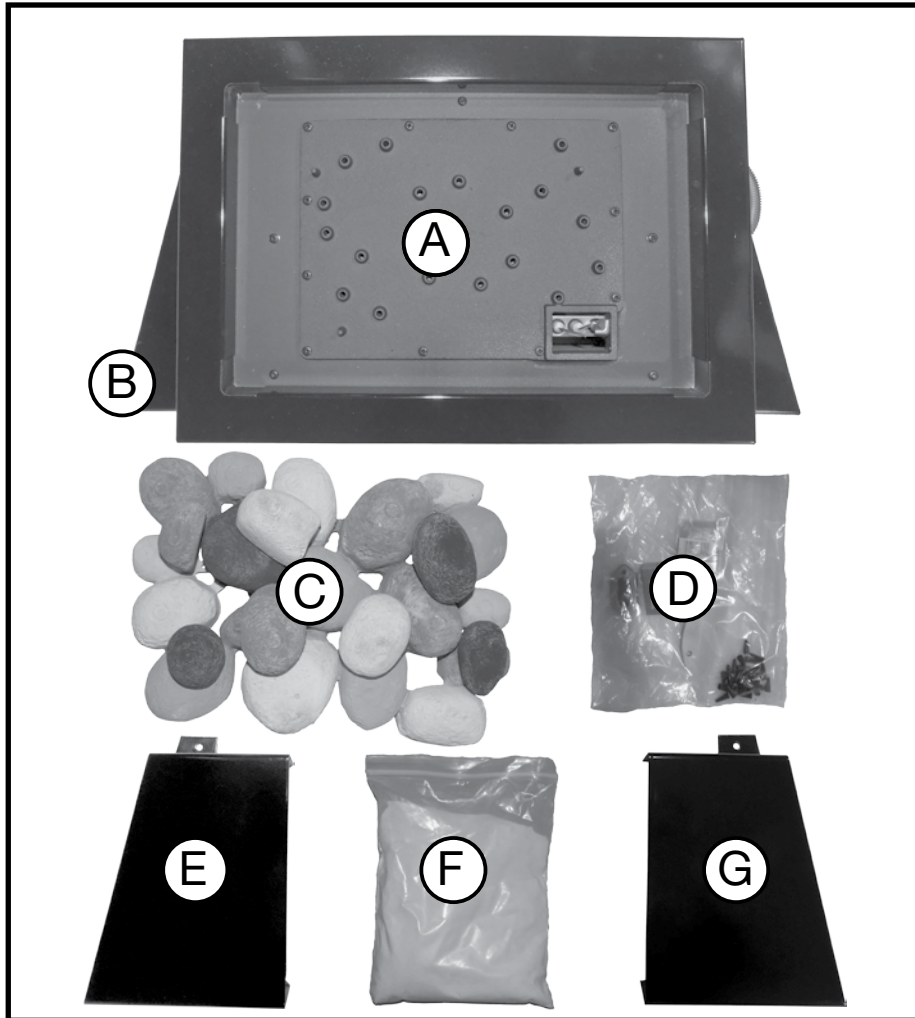

Figure 1: TC30 Tranquility burner kit parts.

- A. Burner assembly (including pilot & gas lines)
- B. Panel, base (attached to burner assembly).
- C. Pebble assembly
- D. Hardware - tapered plugs, screws, brush, panel clips.
- E. Side cover - left hand side.
- F. 2.2 LBS. SAND
- G. Side cover (right hand side)

Tranquility Burner Installation

If converting to propane see conversion instructions on page 13 before proceeding with Tranquility Burner Kit.



Figure 2: 4 holes in fireplace floor to be plugged.

1. Plug the 4 vacant holes in the bottom of the firebox with 1/2" screws, as they are not required to attach this style of burner (Figure 2).

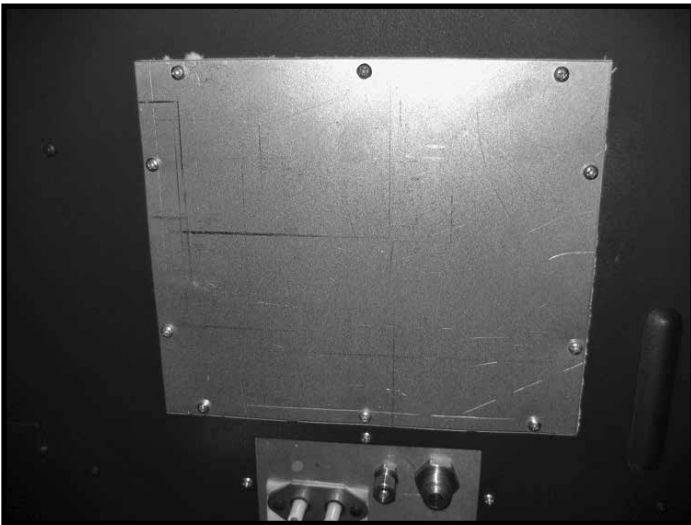

Figure 3: Access cover to valve control center.

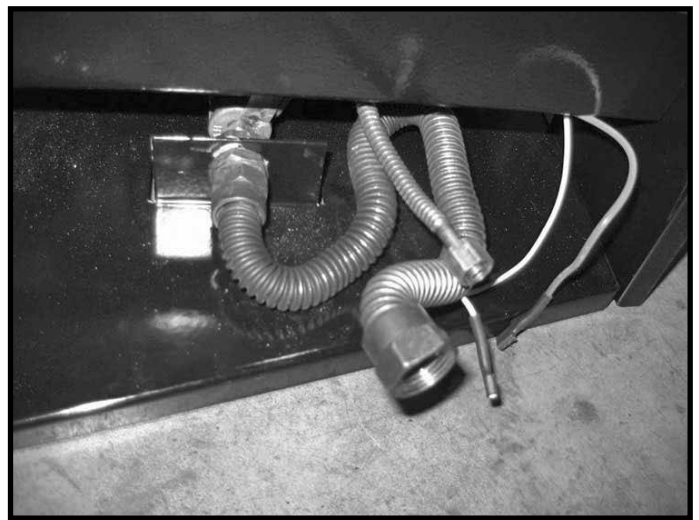

Figure 4: Flex line bent to shape.

2. Remove the 10 screws securing the access cover for the valve control center (Figure 3).
3. Bend the larger gas flex line, the smaller gas pilot flex line and the ignition and sensor wires into shape (Figure 4) so that the right hand side cover will fit over top of them before the burner is placed into the firebox (Figure 6).

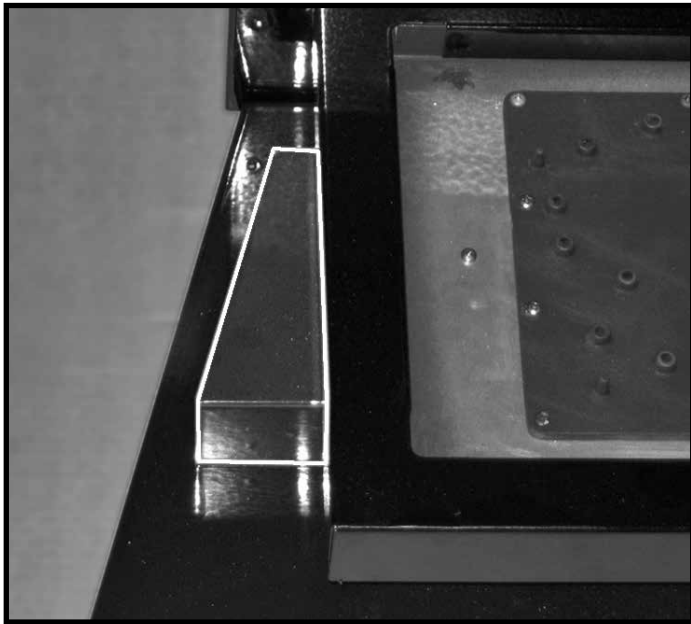

Figure 5: Left hand side cover.

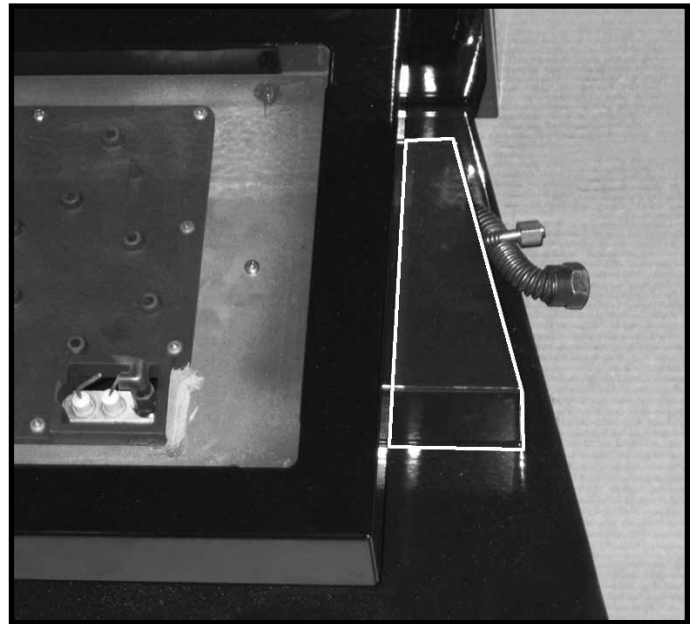

Figure 6: Right hand side cover.

4. Place side covers between the burner tray and its base (Figure 5 and Figure 6) before the burner tray is inserted into the firebox. These will remain in the retracted position until later in the installation process.
5. Position lower rear panel centered at the rear of the firebox. Place burner assembly into the firebox against the rear panel (Figure 7).

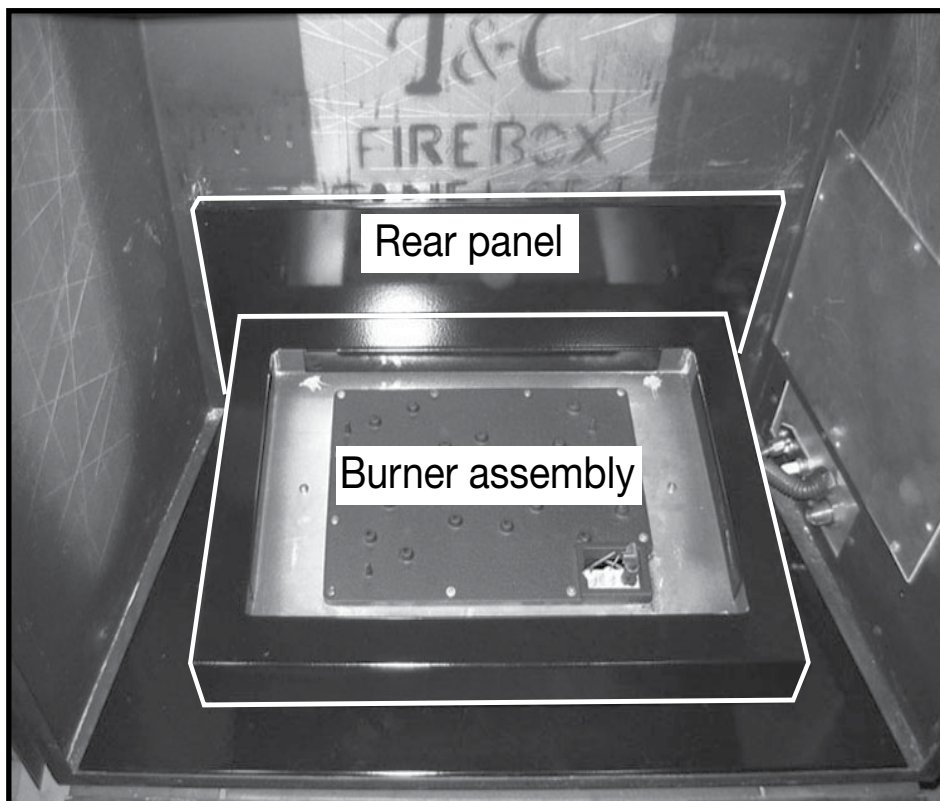

Figure 7: Lower rear panel and burner assembly.

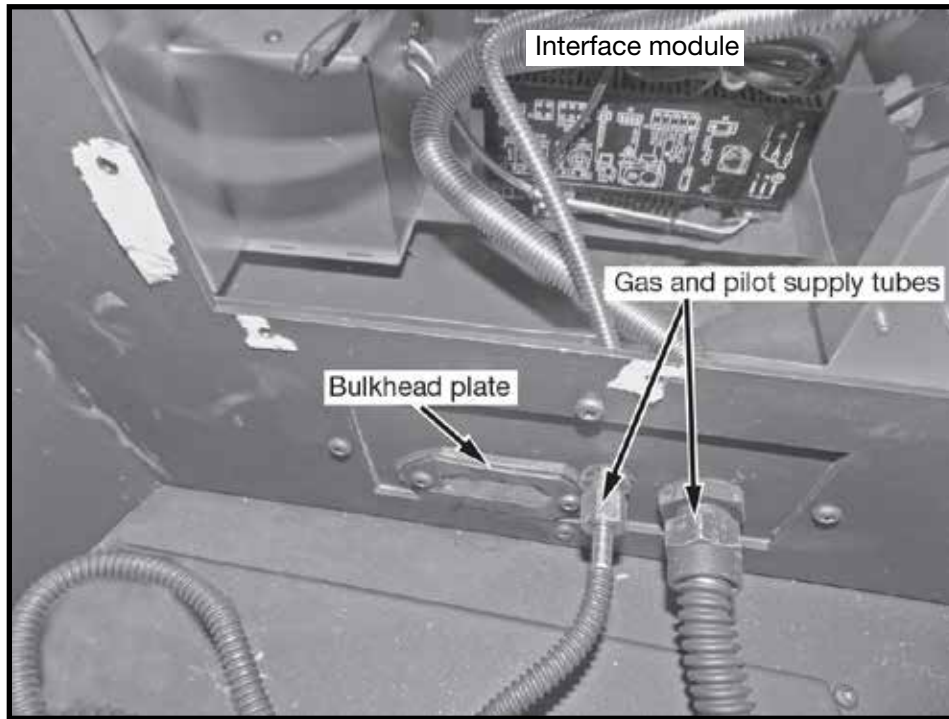

Figure 8: Gas and pilot supply tubes.

6. Attach the main gas supply line and the pilot gas supply line to the bulk head fittings and tighten (Figure 8). Ensure that there are no leaks.
7. Feed the ignition and sensor wires through the bulkhead plate and gasket to the firebox (Figure 9).

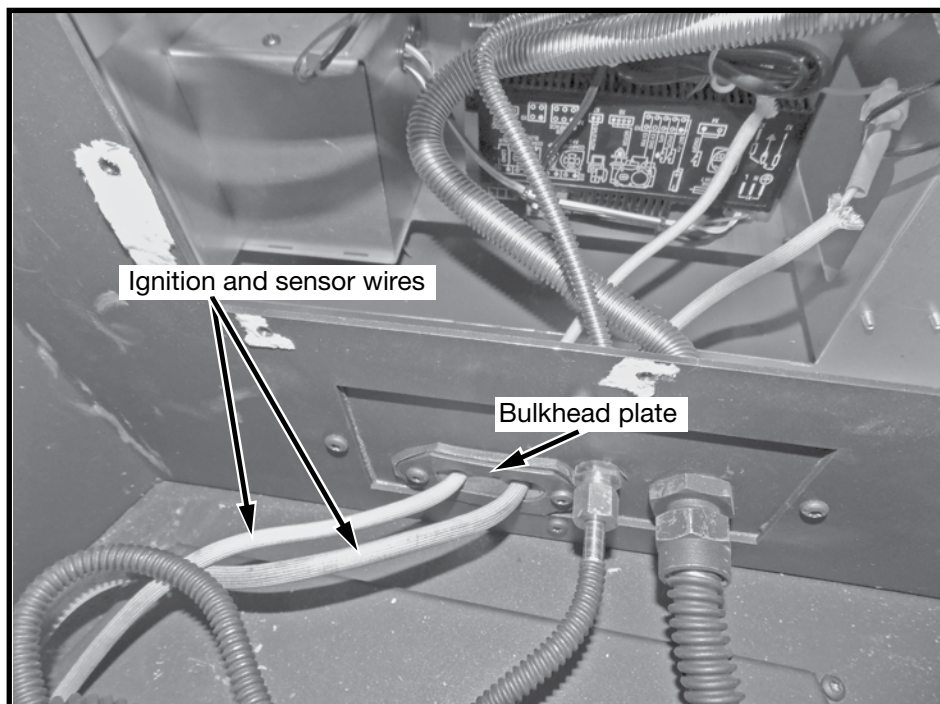

Figure 9: Ignition and sensor wires routing.

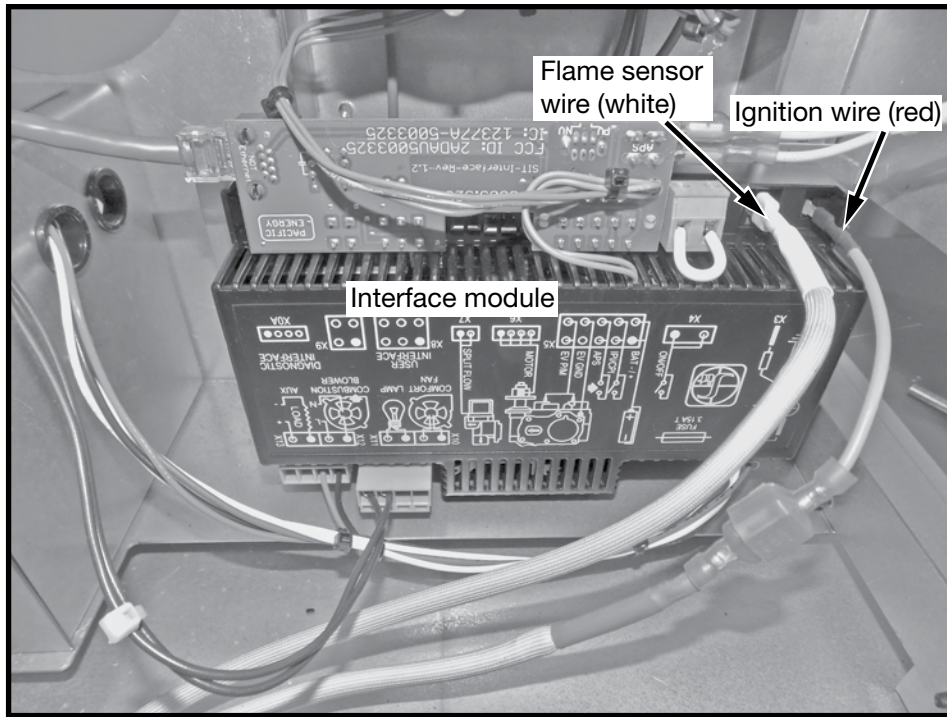

Figure 10: Interface module.

8. Attach the ignition and sensor wires to the interface module as indicated in Figure 10.
9. Once the gas and electrical lines are connected to the bulkhead and the interface module, reinstall the valve control center's access cover (Figure 3 on page 3). The panels are now ready to be installed.

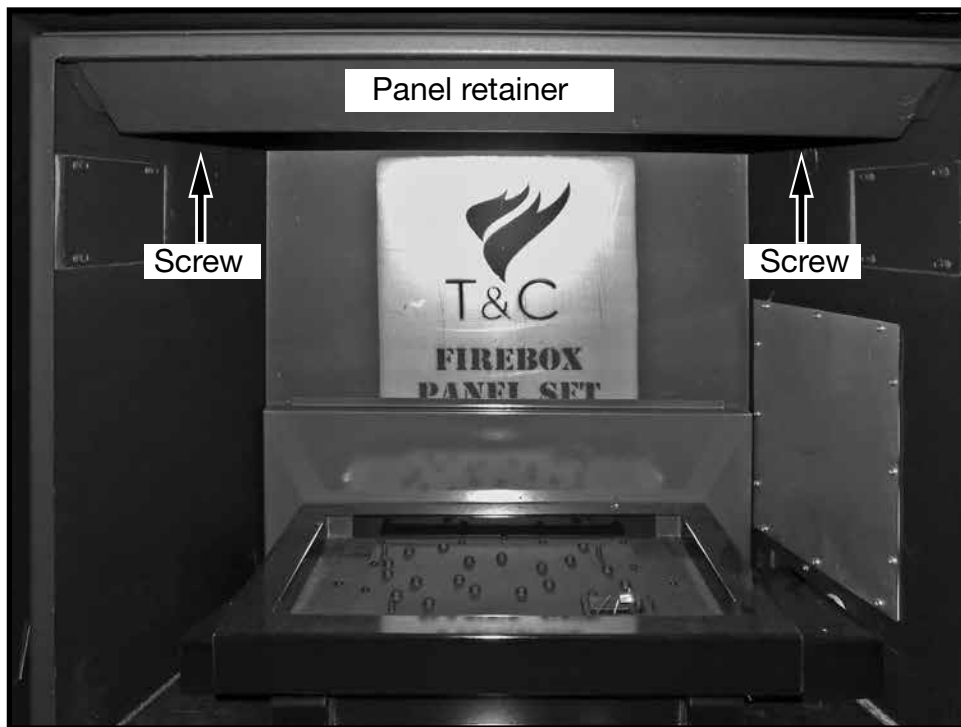

Figure 11: Panel retainer location.



Figure 12: Panel retainer removal.

10. Remove the two screws (Figure 11) which secure the panel retainer to the ceiling. Remove the panel retainer and keep for reinstallation (Figure 12).
11. Attach a panel clip on each of the side panels (Figure 13). These clips will fit over the upper rear panel, holding it in place.

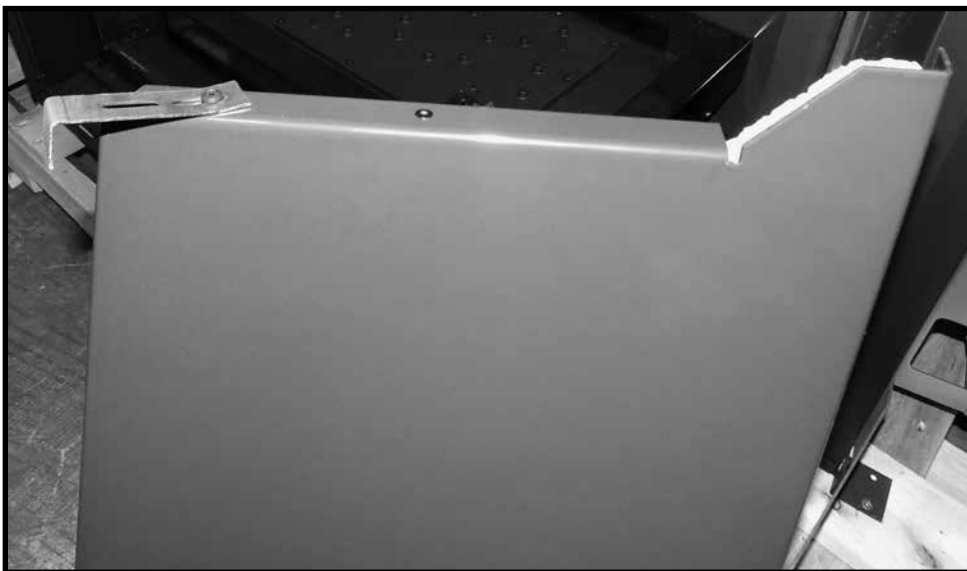

Figure 13: Right side panel with clip attached.

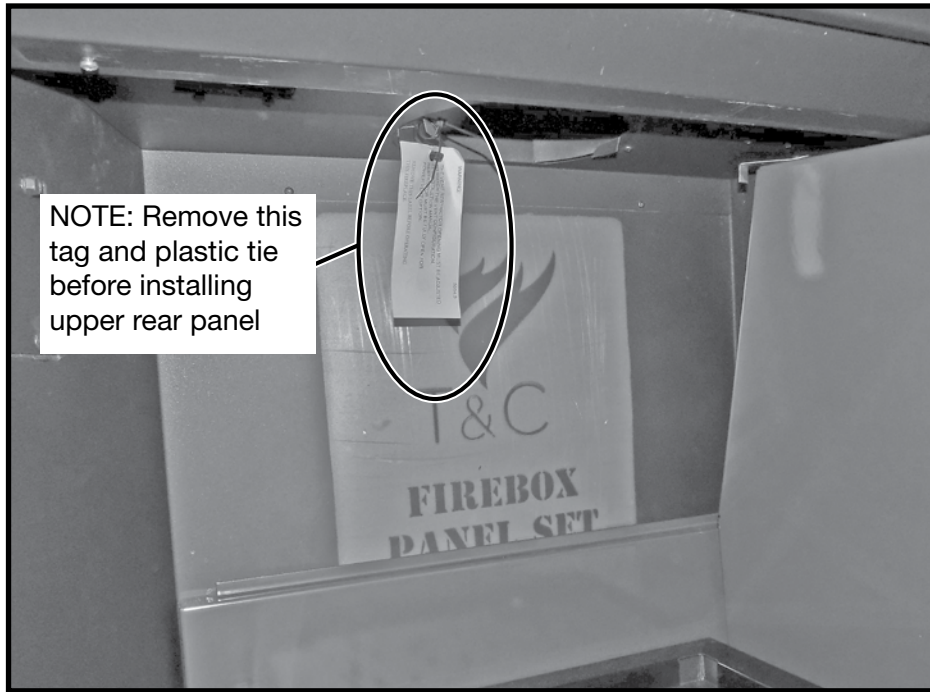

Figure 14: Right side panel partially installed.

12. Remove tag and plastic tie from the flue damper before installing the upper rear panel.
13. Install one of the side panels until it's nearly up against the firebox wall. Leave enough room between the panel and wall so that the upper rear panel can be slipped in behind the side panel.
14. Install the upper rear panel (Figure 15). Place one end on top of the lower rear panel and slip the side of the upper rear panel in behind the side panel. Hold the upper rear panel up against the rear firebox wall until the retaining clip can be positioned over the top of the upper rear panel.

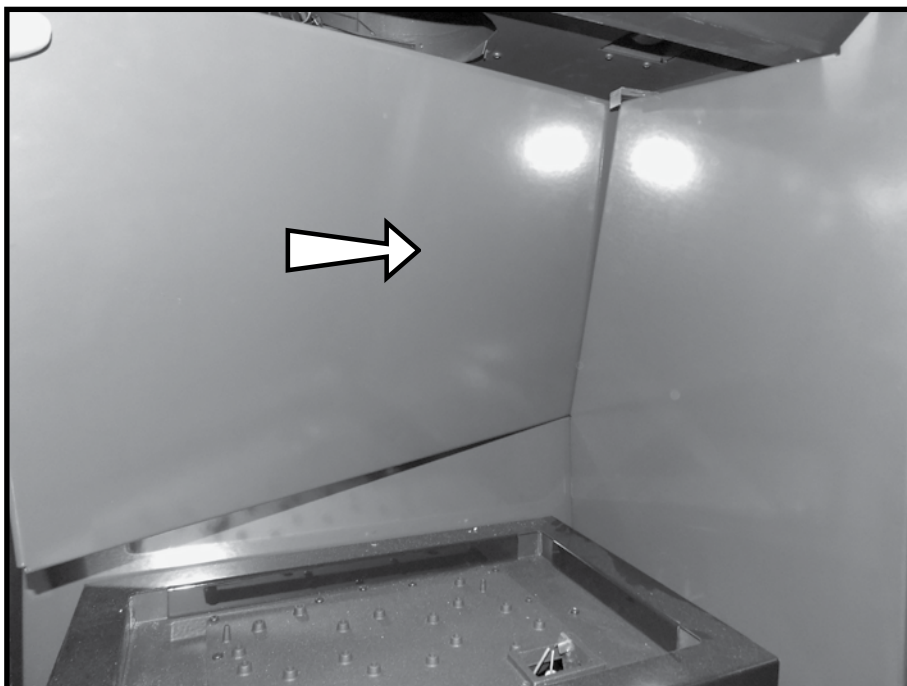

Figure 15: Inserting the upper rear panel.



Figure 16: Left hand side panel installed.

15. Install the other side panel (Figure 16) and bend its retaining clip over the upper rear panel as in the previous step.
16. Reinsert the two screws previously removed from the panel retainer but do not tighten. Reinstall the panel retainer and fit slots to hook onto the two screws. Tighten screws (Figure 17).



Figure 17: Panel retainer reinstalled.



Figure 18: Securing side covers.

17. Move the two side covers previously placed between the burner and its base, out to the side panels. Line the screw holes in the side covers up with the screw holes in the burner tray base. Use supplied self tapping screws to secure the covers to the base (Figure 18).
18. Insert tapered plugs into raised burner ports to prevent sand from entering ports (Figure 19).
19. Place sand in tray. Use supplied brush to spread and level the sand to just below the top of raised burner ports. Gently blow excess sand from around ports (Figure 20).

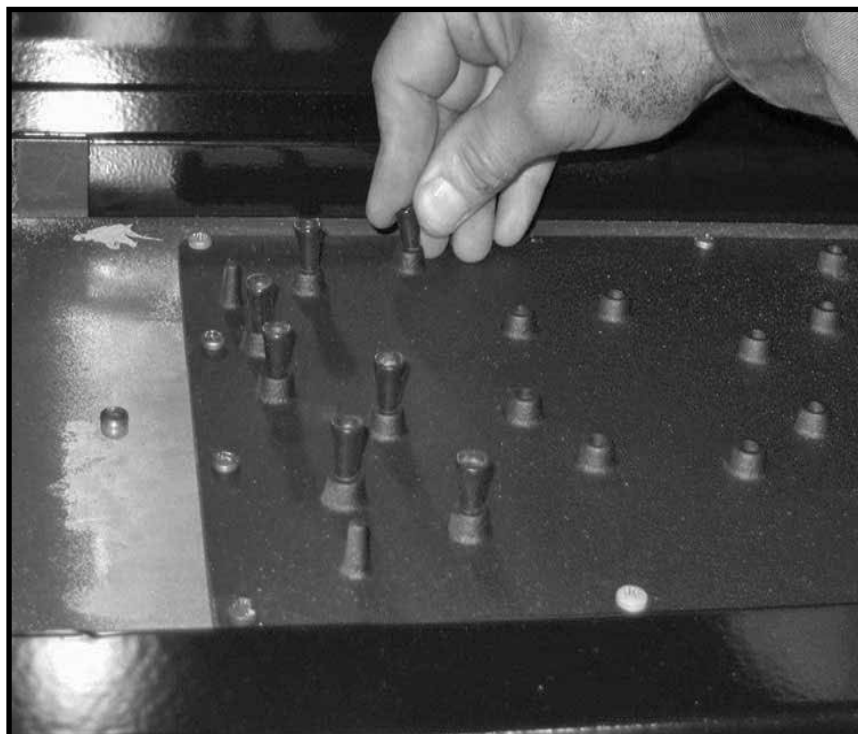

Figure 19: Inserting tapered plugs.



Figure 20: Applying sand to burner tray.

20. Remove tapered plugs from ports.
21. Remove pebble assembly from packaging by placing hand on top and tipping upside down. Note that the rock in the lower left is hollow underneath and will fit over top of the pilot assembly (Figure 21).
22. Gently place pebble assembly onto sand base aligning 3 holes in the bottom of the rock set to the 3 pins located on the burner tray (Figure 22).

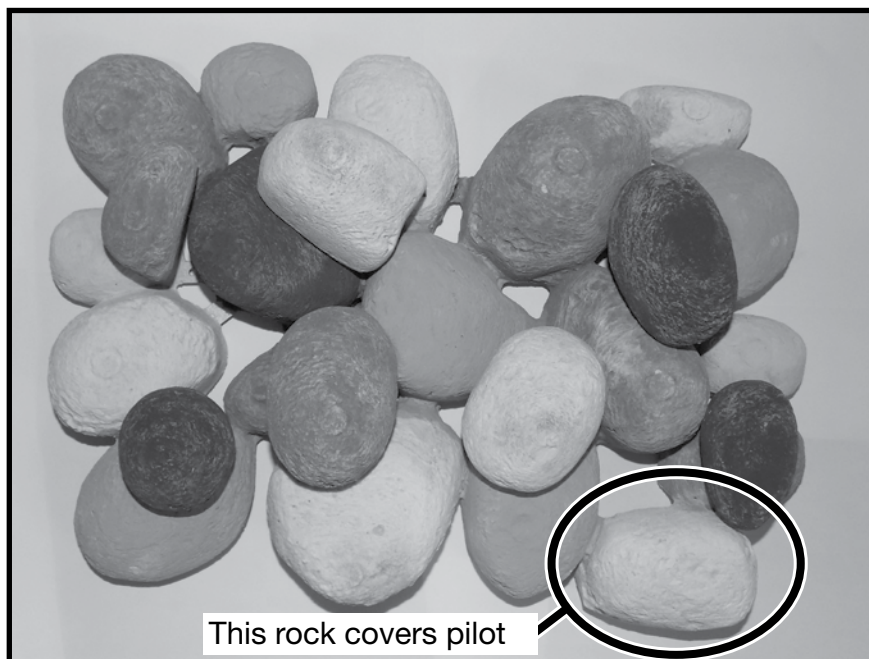

Figure 21: Rock set.

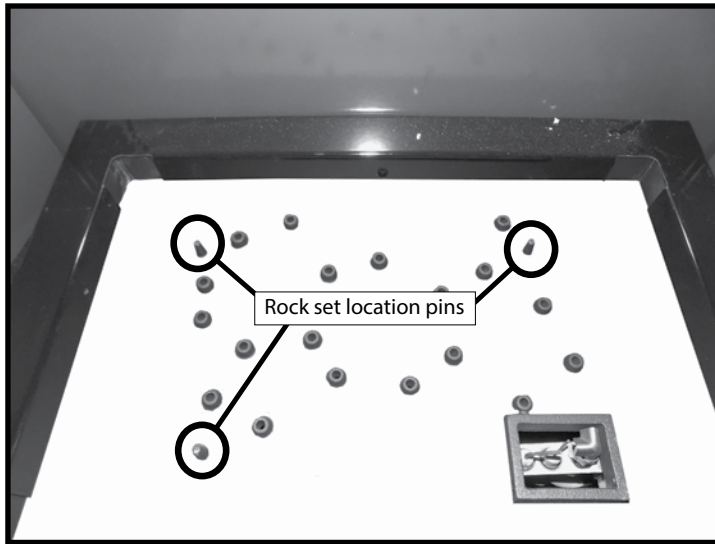

Figure 22: Location pins for rock set.

23. Install glass door. Unit is ready for lighting.



Figure 23: Rock set in place.

Note: The base panel (Figure 24) is not used with the Tranquility burner and is a left over item.



Figure 24: Base panel.

Propane Conversion

WARNING

This conversion kit shall be installed by a qualified service agency in accordance with the manufacturer's instructions and all applicable codes and requirements of the authority having jurisdiction.

If the information in these instructions is not followed exactly, a fire, explosion or production of carbon monoxide may result causing property damage, personal injury or loss of life.

The qualified service agency is responsible for the proper installation of this kit. The installation is not proper and complete until the operation of the converted appliance is checked as specified in the manufacturer's instructions supplied with the kit.

CAUTION

The gas supply and electrical power shall be shut off before proceeding with the conversion.

Note: Factory supplied components must be used to ensure correct input. After conversion confirm proper manifold pressure.

If the unit is to be used on propane convert as follows using the components supplied with this burner:



Figure 25: Access panel.

1. Remove rock set and sand if present.
2. Remove right hand side panel if present.
3. Remove all 10 screws from the Valve control center panel (Figure 25).

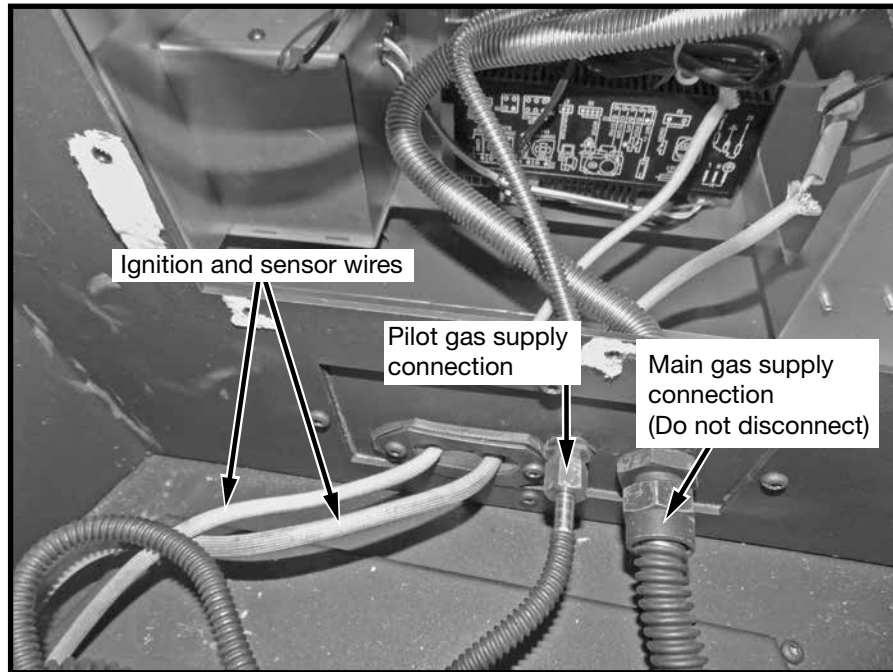

Figure 26: Connections at bulkhead.

4. Disconnect the pilot gas supply line at the bulkhead (Figure 26). DO NOT disconnect the main gas supply line from the bulkhead.

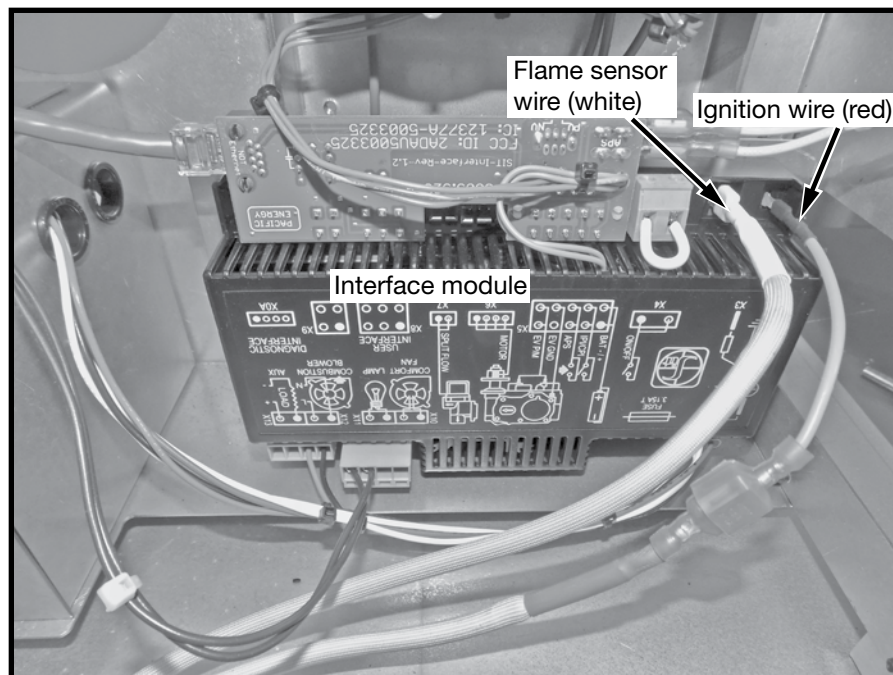

Figure 27: Disconnecting flame sensor and ignition wires at interface module.

5. Disconnect the flame sensor wire and the ignition wire from the interface module (Figure 27) and withdraw the wires back through the bulkhead plate and into the firebox area.

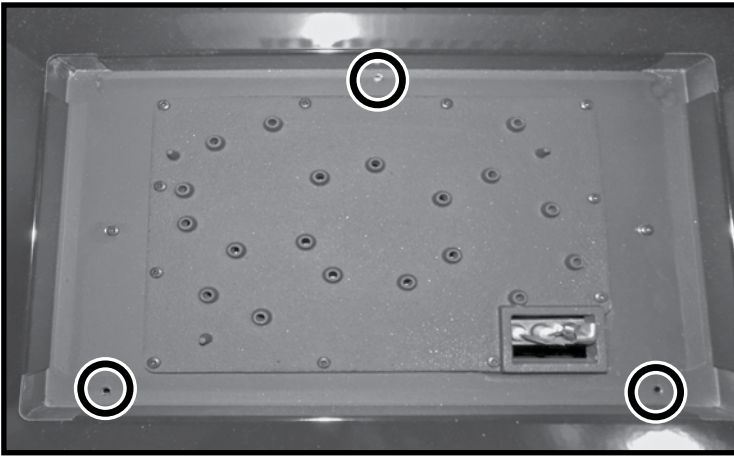

Figure 28: Removing front burner tray screws.

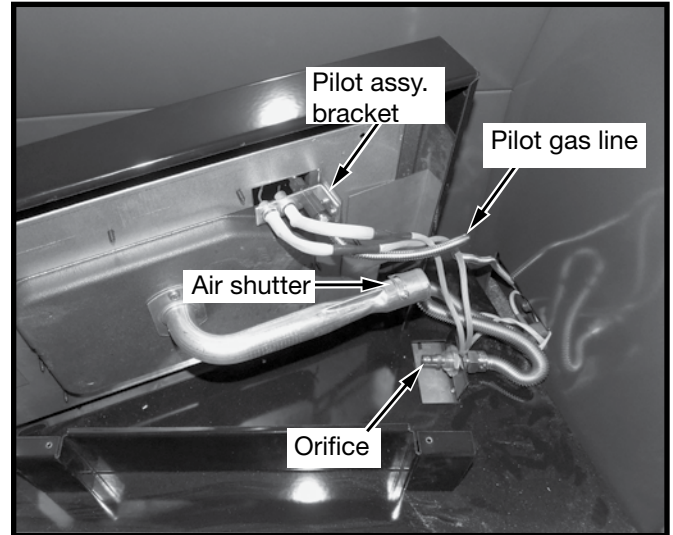

Figure 29: Underside of burner.

6. Remove the 2 front and 1 rear screws holding the burner tray in place (Figure 28).
7. Gently lift up the burner tray from its supports while sliding it to the left to disengage the burner tube from the orifice. Lift the tray, turn it on its side and lay it on its edge to expose the orifice and the pilot assembly (Figure 29). Remove the pilot assembly bracket with its wires and pilot gas line attached while the burner kit is on its side (See “Figure 33” on page 16).
8. Using a 1/2” wrench, undo the natural gas burner orifice (Figure 29) and replace with the propane gas orifice that comes with the conversion kit (Figure 30). Apply a small amount of pipe joint compound to the threads of the propane burner orifice to ensure a good seal, before screwing it into the fitting.



Figure 30: Orifice.

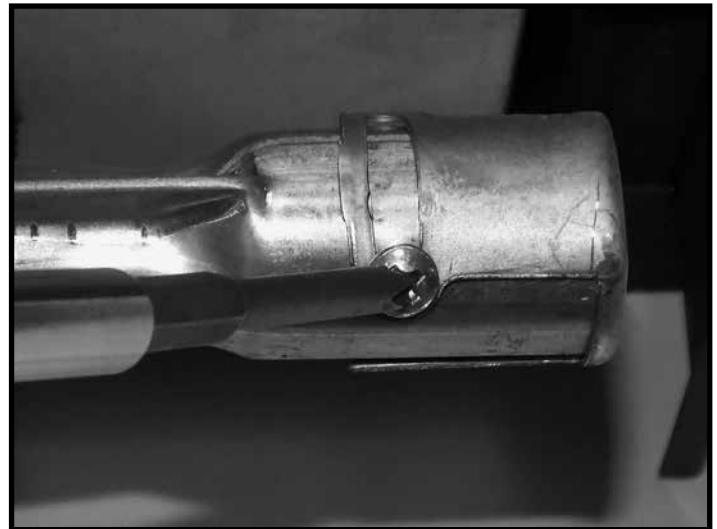

Figure 31: Air shutter fully closed for natural gas.



Figure 32: Air shutter half opened for propane gas.

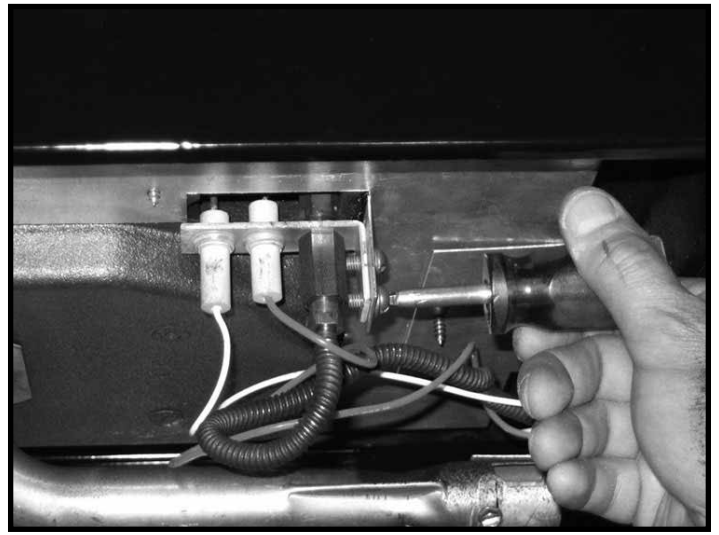

Figure 33: Removing pilot assembly.

9. Loosen the primary air shutter screw (Figure 31), open shutter half way and re-tighten (Figure 32).
10. Remove the 2 screws holding the pilot assembly in place with a short screwdriver (Figure 33).
11. With a 7/16" wrench, loosen the pilot head on the pilot assembly using a wrench to hold the bracket steady (Figure 34).

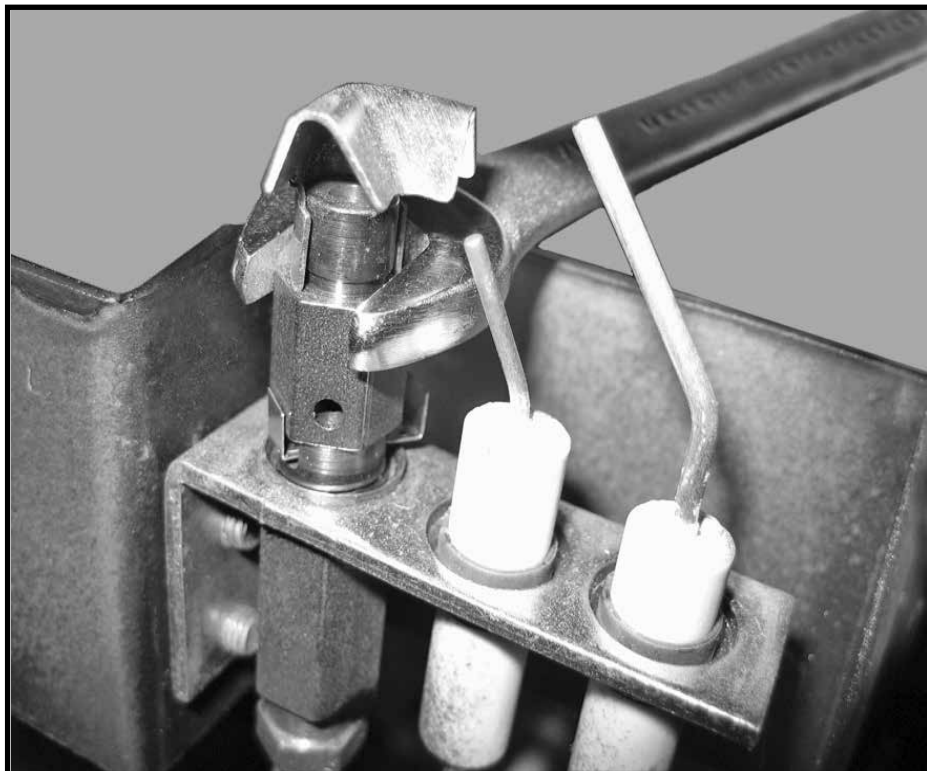

Figure 34: Loosening pilot shield.

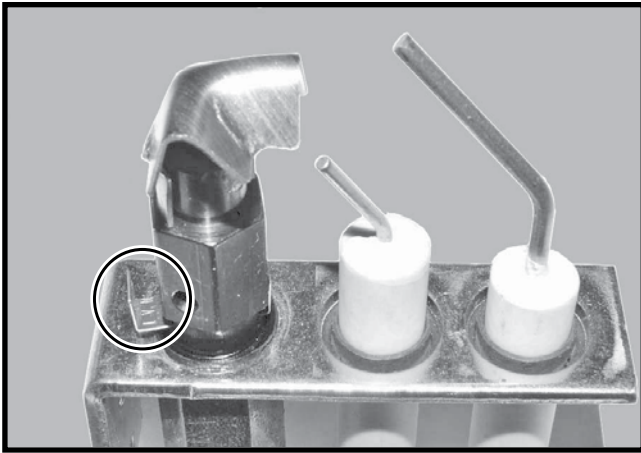

Figure 35: Band in natural gas position.

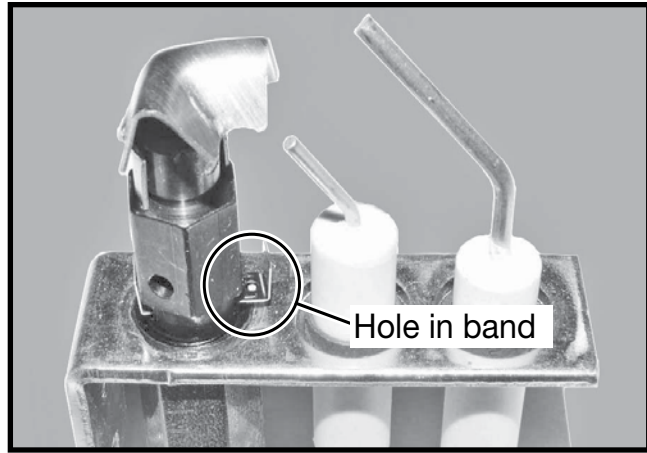

Figure 36: Band in liquid propane position.

12. Slide the pilot adjustment band over and ensure that the hole in the orifice band is showing. Figure 35 shows the pilot in the natural gas position. Figure 36 shows the pilot in propane gas position.
13. Fill in the conversion label (Figure 37) . Peel off the protective backing and apply the conversion label directly over the gas specifications on the rating label. Rating label can be found on a metal plate stored on the left hand side of the fireplace, behind the decorative trim.
14. Reattach the access cover, right hand enamel panel piece, burner tray, sand and rock set.

This appliance was converted to propane gas	
Kit Number	PACIFIC ENERGY
dd / mm / yy	5052.52001-B
Company	conversion a été correctement faite.
Address	responsabilité que cette ci-dessus accepte la l'entreprise désignée
The above accepts the responsibility that this conversion has been properly performed.	Adresse
	Firme
	j / m / a
5052.52001-B	Numéro d'assemblage
PACIFIC ENERGY	
Cet appareil a été converti en gaz propane	

Figure 37: TC30 Propane gas conversion Label.

For complete valve installation instructions, refer to the instruction book included in the SIT conversion kit.

Gas Pressure Check

Note: To test the gas pressure, turn off the gas supply before removing the plug from the supply pressure test port or manifold pressure test port.

Verify gas pressures with the fireplace lit and on the highest setting.

1. Remove the plug from the pressure test port. The plug is located between the right side lintel and firebox side (Figure 39).
2. Thread the extension test fitting into the open port (Figure 40).
3. Attach a pressure gauge onto the fitting.
4. When testing is complete shut off the gas, remove the fitting and replace the plug. Thread sealant will be required to ensure a gas tight connection.



Figure 38: Removing manifold pressure plug.

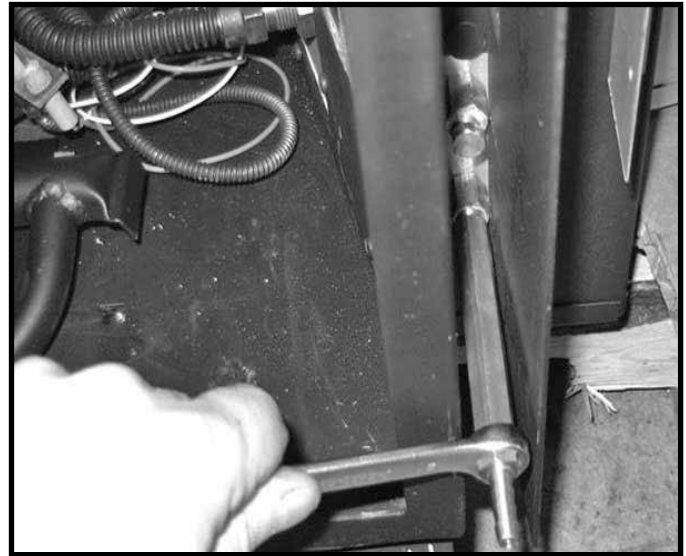

Figure 39: Adjusting manifold pressure.

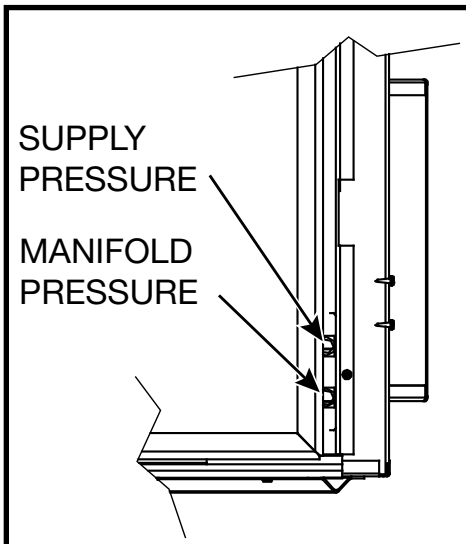

Figure 40: Gas test ports.

Correct gas pressure requirement:

Supply Pressure	Natural Gas	Propane
Min. Pressure	5.0" WC	12.5" WC
<small>(For purpose of input adjustment)</small>		
Max. Pressure	13.9" WC	13.9" WC
Manifold Pressure		
Maximum	3.5" WC	10" WC
Minimum	1.6" WC	6.4" WC

Burner Flame Adjustment

The air shutter on the burner tube controls the primary combustion air. It is set to the closed position at the factory for natural gas fuel. Some adjustment may be necessary to obtain desired flame and to eliminate carbon deposits. Evaluate flame appearance after the fireplace has reached operating temperature. See (Figure 42) for proper flame pattern.

Open primary air if the window glass and firebox have carbon accumulation and/or the flames are long, dark and stringy. The shutter may also be opened to lessen the flame height.



Figure 41: Desirable flame appearance.

NOTE:

Proper air shutter setting is required, fully closed for natural gas and half open for propane.

The flame should be just orange and “lazy”. It should NEVER be set to create sooting on internal parts and window glass.

Replacement Parts

(WHEN ORDERING, INCLUDE PART NUMBER WITH DESCRIPTION)

ITEM	DESCRIPTION	PART NO.	ITEM	DESCRIPTION	PART NO.
#1	TRANQUILITY BURNER KIT	22150002	#5	PILOT ASSEMBLY, CONVERTIBLE	TCRP.5005025
#2	PEBBLE ASSEMBLY	TC36.9499	#6	ORIFICE, NATURAL GAS (#32).....	5021.332A
#3	MAIN SUPPLY TUBE	5019.223	* #7	SAND	TC36.SAND22
#4	PILOT TUBE.....	5019.225	* #8	PROPANE CONVERSION KIT.....	TC30.DLPKIT

* NOT SHOWN

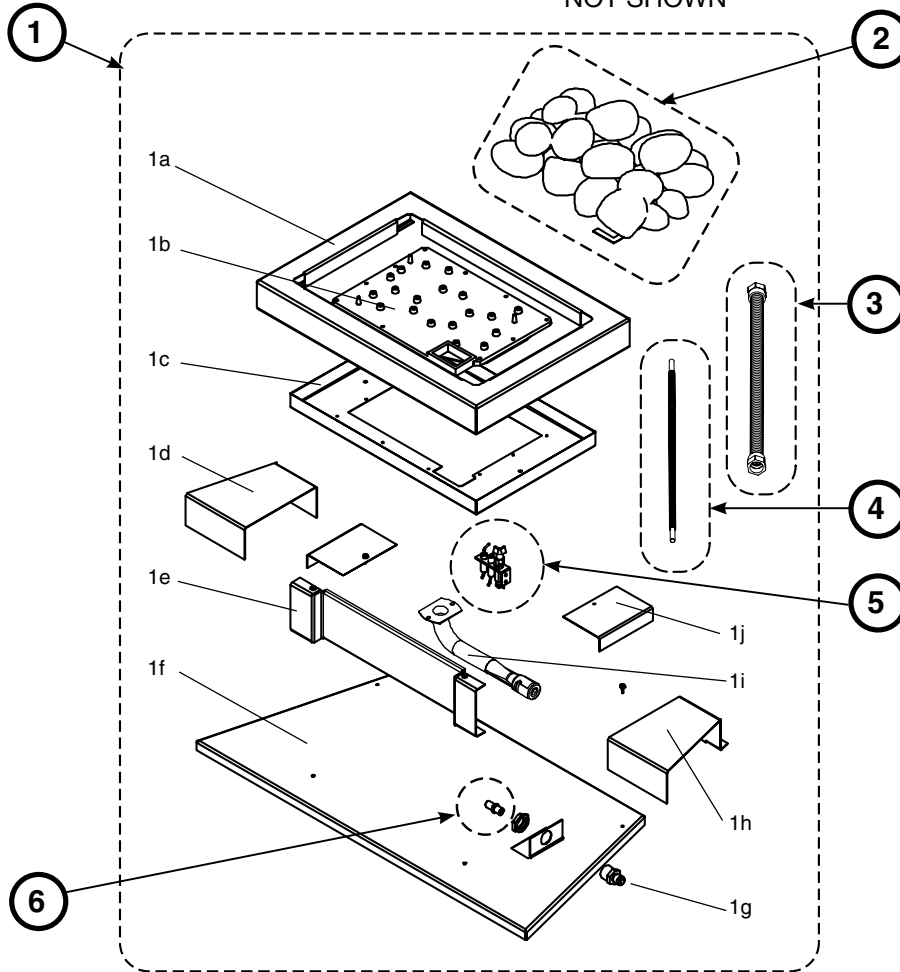

KIT CONTENTS:

#1 BURNER ASSEMBLY

- 1a.....TRANQUILITY CURB
- 1b..... 19 PORT CAST BURNER
- 1c.....ROCK PAN
- 1d..... LINE COVER, LT
- 1e..... TRANQUILITY LEG
- 1f..... FLOOR PAN
- 1g..... TAPPED 1/8-27 NPT
- 1h..... LINE COVER, RT
- 1i..... BURNER INLET TUBE
- 1j..... CURB CLAMP

- #2 PEBBLE ASSEMBLY
- #3 MAIN SUPPLY TUBE
- #4 PILOT TUBE
- #5 PILOT ASSEMBLY, CONVERTIBLE
- #6 ORIFICE NG #32
- #7 PROPANE CONVERSION KIT (not shown)
- #8 SAND (not shown)



© 2017 Copyright Pacific Energy Fireplace Products LTD

Reproduction, adaptation, or translation
without prior written permission is prohibited,
except as allowed under the copyright laws.



For technical support, please contact your retailer.

**Web site: www.townandcountryfireplaces.net
2975 Allenby Rd., Duncan, BC V9L 6V8**