

**INSTALLER: Leave this manual with the appliance.
CONSUMER: Retain this manual for future reference.**

These instructions are supplementary to the Installation and Operating Instructions supplied with the fireplace and should be kept together. Refer to the Installation and Operating Instructions for proper gas supply, safety requirements and operating instructions



TOWN & COUNTRY
L U X U R Y F I R E P L A C E S

TC30 HEARTWOOD BURNER INSTALLATION INSTRUCTIONS



**SKU# 22150009
FOR TC30 Series D
Fireplaces**



Visit www.townandcountryfireplaces.net for the most recent version of this manual

Contents of Package

- BURNER ASSEMBLY
(including pilot and manifold)
- LOG GRATE
- TC30 HEARTWOOD LOGS
- EMBER MATERIAL
- HARDWARE PACKAGE
- COAL CHUNKS
- VERMICULITE



Burner Installation

If this fireplace is to be used on Propane please convert prior to installation. See pages 10 – 12.

1. Place the keyhole slots in the burner over the two screws located in the firebox base. (Fig. #1 & 1a)
2. Slide the burner back to engage the screws in the small part of the keyhole slot and tighten screws. (Fig. #1b)
3. Remove access cover from side of firebox(Fig. #1c)



SCREWS

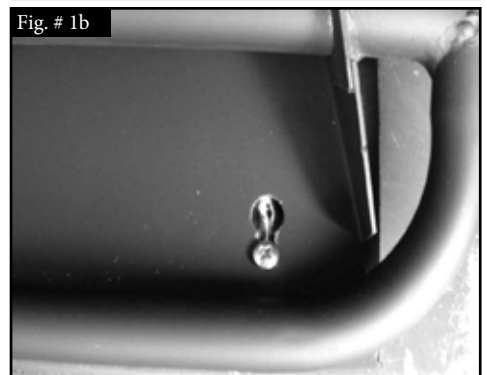
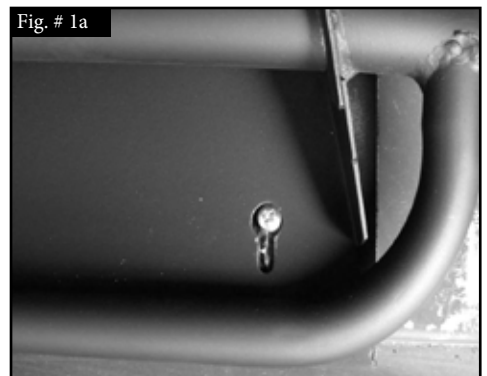
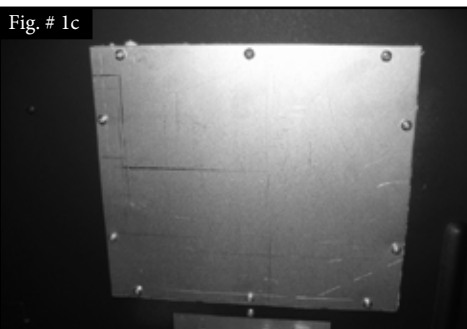

Burner/ Grate Installation

4. Feed the ignition and sensor wires through the bulkhead plate (Fig. #2) to the interface module. (Fig.#3).

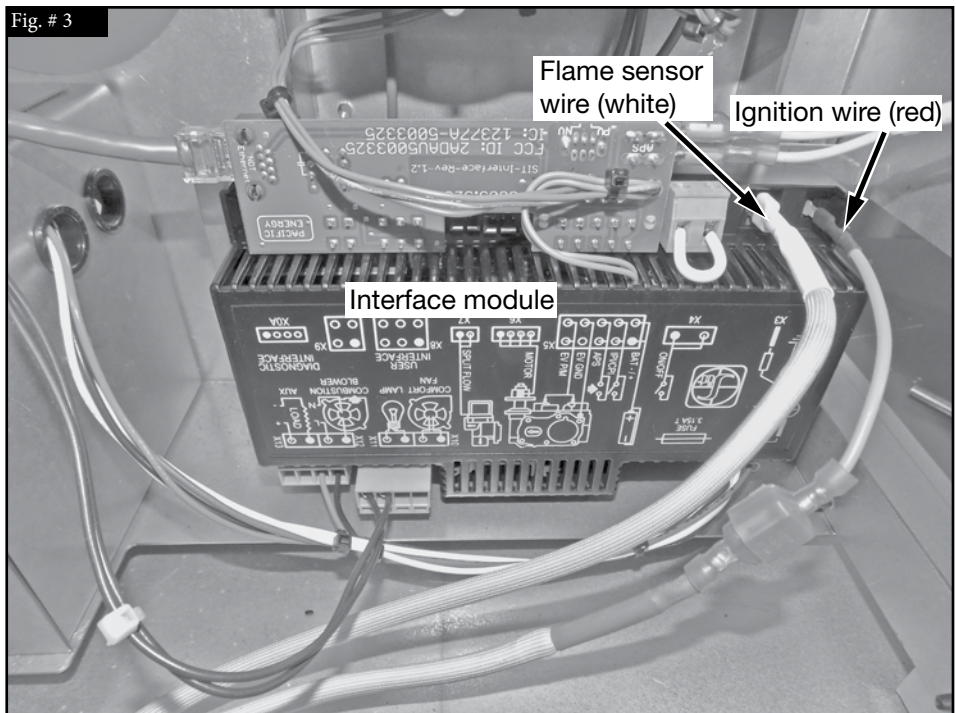
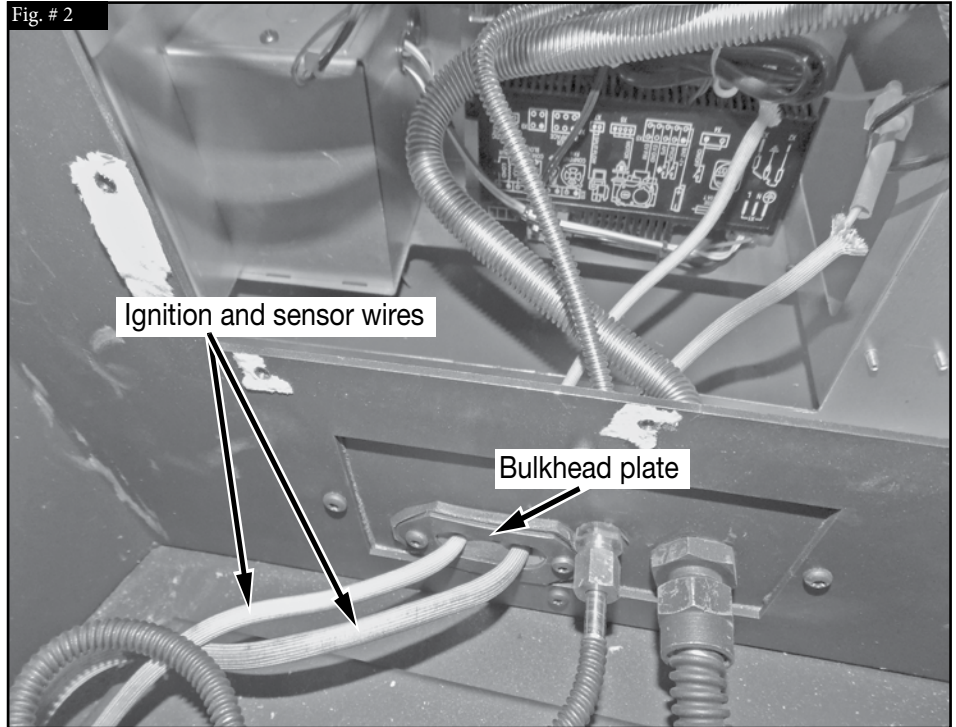

5. Attach the pilot and gas supply tubes to the bulk head fitting and tighten. (Fig. # 3b) Ensure the connections are gas tight. Conceal the spark and sensor wires below the supply tubes.

A panel set must now be installed. See Installation and Operating Instructions manual for details.

Fig. # 3b

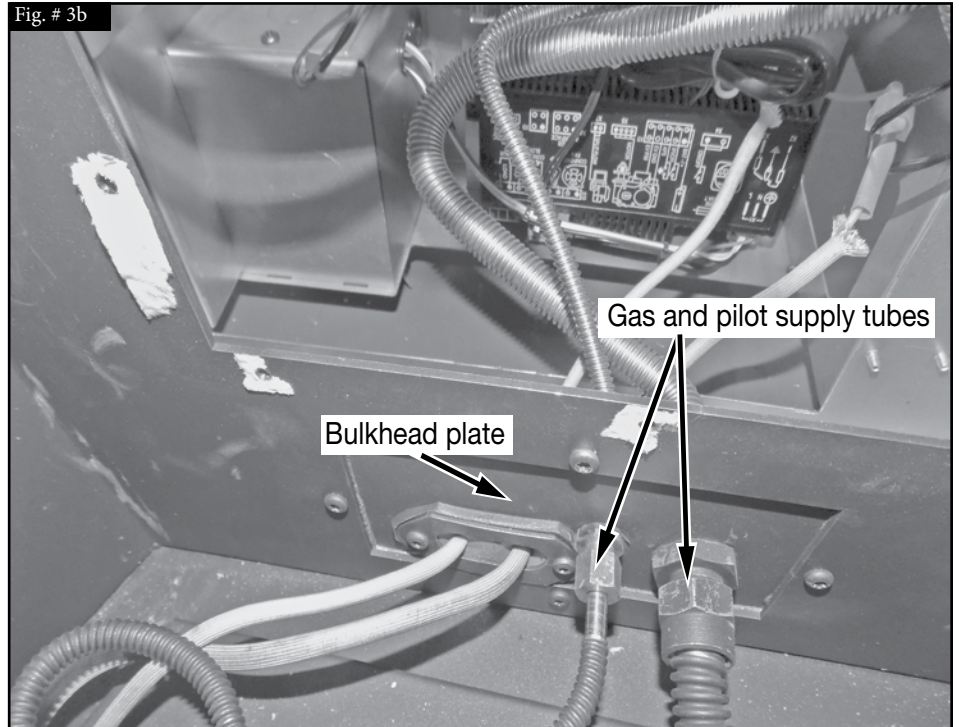

6. Position the slots of the grate securing brackets over the holes in the floor shield and secure with the two screws (Fig. # 4).

Fig. # 4



Ember Material

A large bag of ember material is shipped with the fireplace and needs to be installed on the burner to ensure optimum performance and flame appearance. A bag of coal chunks and vermiculite is also supplied this **must** only be used **around** the burner pan to cover up the gas lines and brackets.

1. Pull apart the material into ember size pieces (approximately 1" square) and gently place them into the burner pan. Do not compress, leave them loose for best performance.
2. Fill the burner pan with embers until level with the top of the pan at rear, and gradually slope forward to the firebox floor at the front, covering both burner tubes.
3. Place remaining ember material, coal chunks and vermiculite outside of the burner pan as desired to cover-up gas lines and brackets. **Do not put coal chunks or vermiculite inside burner pan as this will cause sooting and the burner to malfunction.**

Note:

Ember material placement and amount will affect flame appearance.

More ember material results in lower flame height.

Add or remove as needed until desired flame affect.

Reduce the amount used on Propane models, as too much will create soot

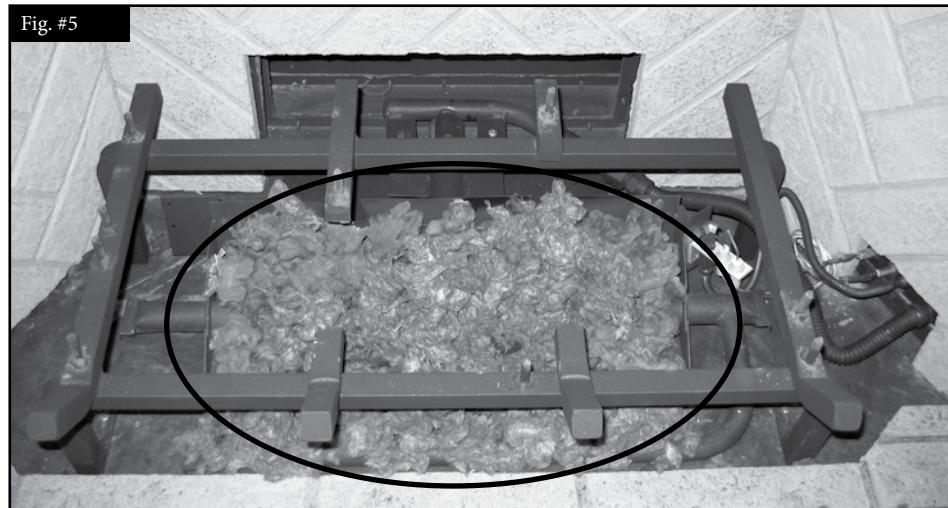

Embers only in this area.



Embers, coal chunks and vermiculite.

Log Placement

Gas plumbing and vent connections should be completed before proceeding.

The logs are fragile, and should be handled with care. Unpack and inspect log set. There should be a total of seven logs.

Position the logs as indicated by the following pictures. The seven main logs have holes and/or pins. Engage each pin in the corresponding holes. The remaining two logs do not have holes or pins. They rest in position. Locate as per the diagrams (fig. # 7-15)

Note: Improper placement of logs will cause sooting on internal parts and glass. The logs may need to be repositioned slightly to avoid excessive flame impingement.

Fig. # 7



Fig. # 8



Fig. #9

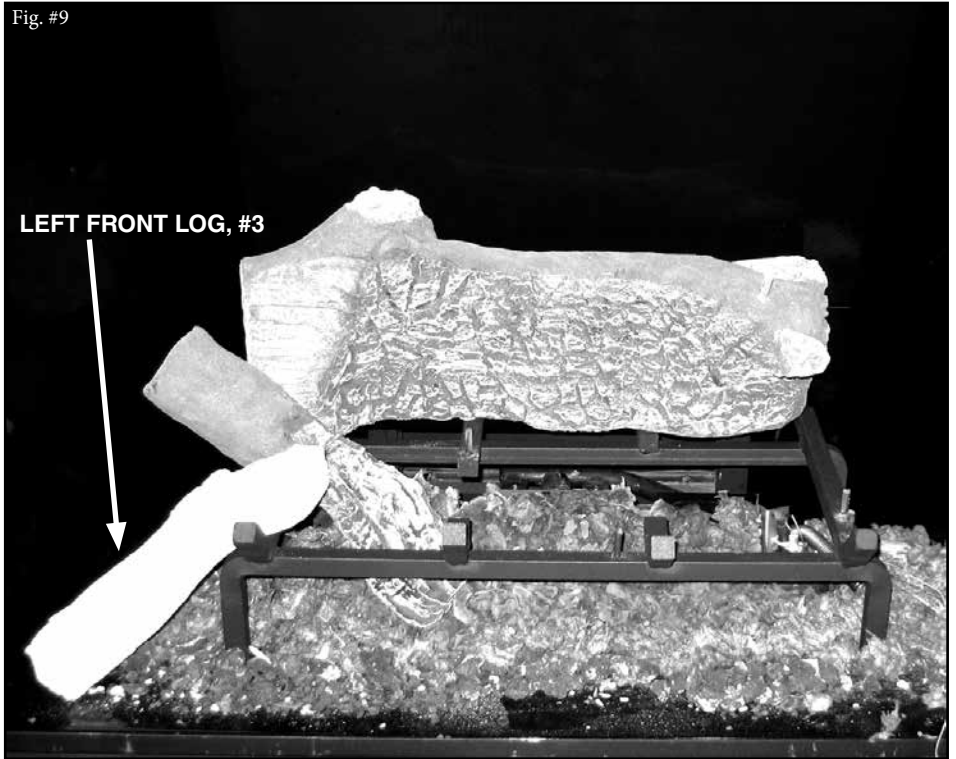

Fig. #10

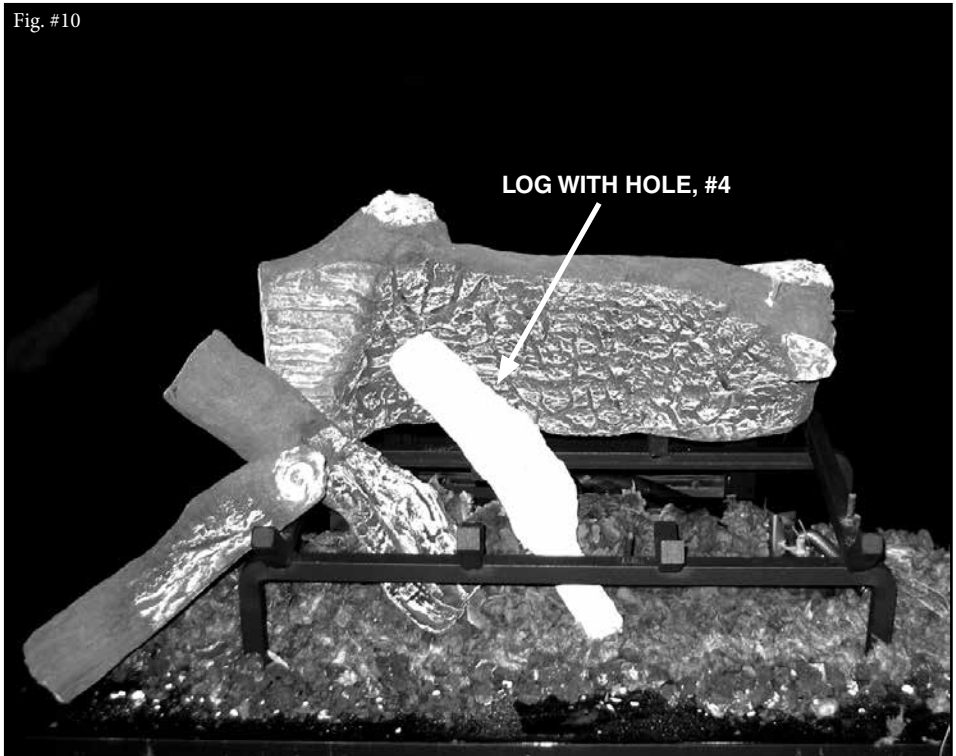

Fig. #11

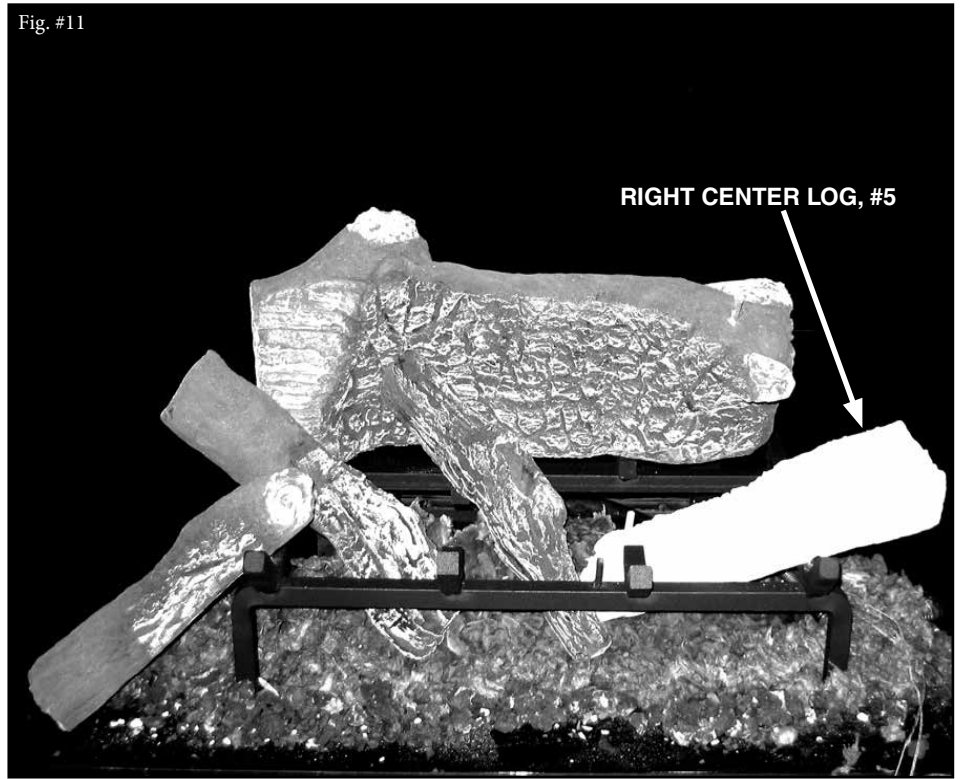

Fig. #12

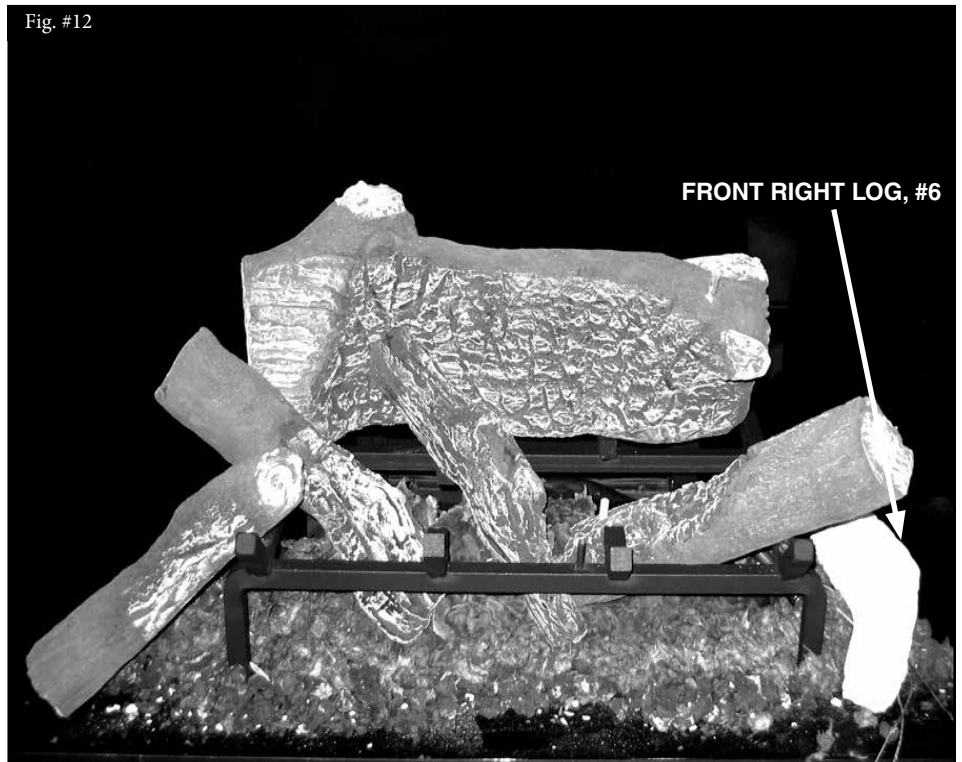

Fig. #13

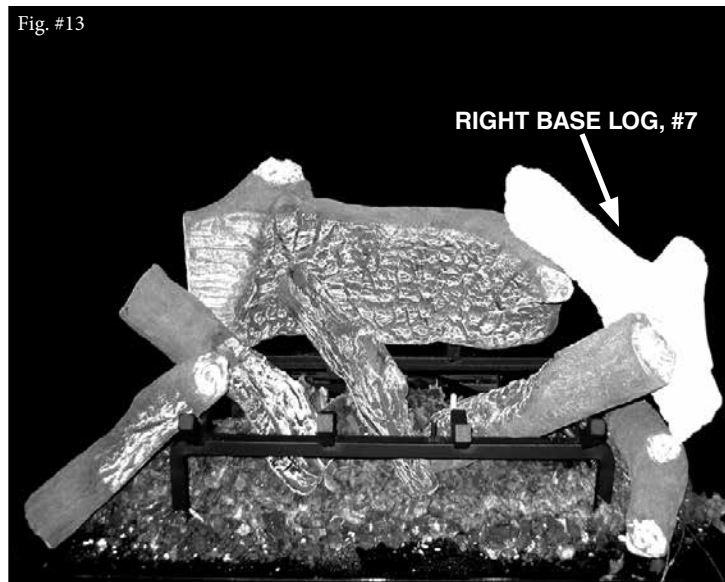
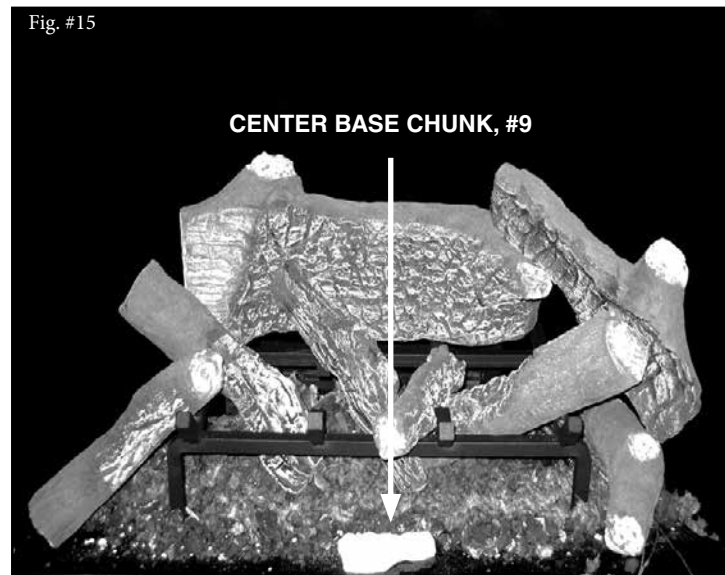

Fig. #14



Fig. #15



Propane Conversion

If the unit is to be used on propane, convert as follows using the components supplied with this fireplace:

Note: Factory supplied components must be used to ensure correct input.
After conversion confirm proper manifold pressure.

CAUTION

The gas supply and electrical power must be shut off before proceeding with the conversion.

WARNING

This conversion kit shall be installed by a qualified service agency in accordance with the manufacturer's instructions and all applicable codes and requirements of the authority having jurisdiction.

If the information in these instructions is not followed exactly, a fire, explosion or production of carbon monoxide may result causing property damage, personal injury or loss of life.

The qualified service agency is responsible for the proper installation of this kit.

The installation is not proper and complete until the operation of the converted appliance is checked as specified in the manufacturer's instructions supplied with the kit.

1. Ensure the burner, pilot and gas supply are turned off, and the appliance has cooled.
2. Remove the two screws securing the manifold assembly to the burner. (Fig. #16)
3. Remove the manifold assembly from the burner. (Fig. #17)
4. With a ½" wrench remove the natural gas orifice and replace with propane orifice (1.9 mm) (our part # 5022.76) (Fig. #18)
5. Fully open the primary air shutter.
6. Reinstall the manifold assembly and air deflector.

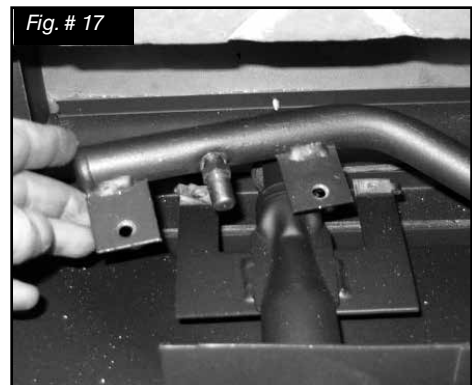
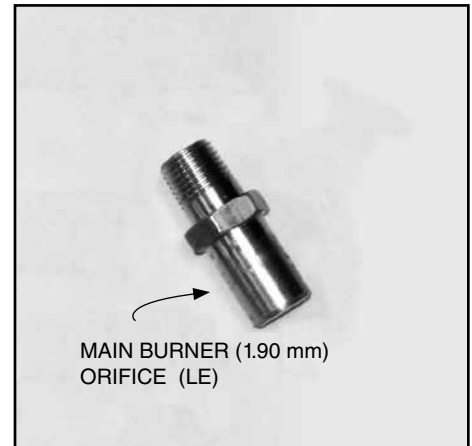

Gas Pressure Check

Note: To test the gas pressure, turn off the gas supply before removing the plug from the supply pressure test port or manifold pressure test port.

Verify gas pressures with the fireplace lit and on the highest setting.

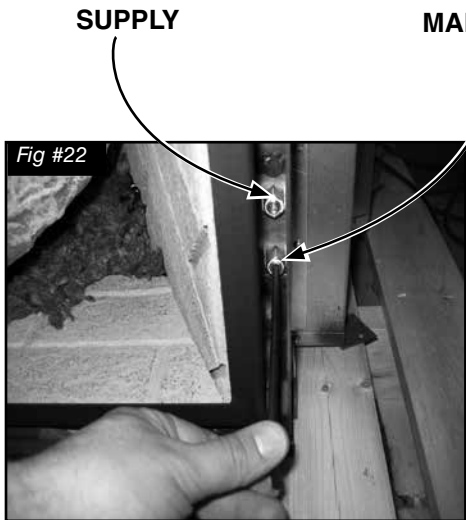

1. Remove the plug from the manifold test port. The plug is located between the right side lintel and firebox side (bottom port). (Fig. # 22)



2. Thread the extension test fitting into the open test port. (Fig. #23)
3. Attach a pressure gauge onto the fitting.
4. When testing is complete remove the extension test fitting and replace the plug. Thread sealant will be required to ensure a gas-tight connection.

Correct gas pressure requirement:		
Supply Pressure <small>(For purpose of input adjustment)</small>	Natural Gas	Propane
Minimum	5.0" WC	12.5" WC
Maximum	13.9" WC	13.9" WC
Manifold Pressure		
Maximum	3.5" WC	10.0" WC
Minimum	1.6" WC	6.4" WC

Flame Adjustment

The air shutter on the burner tube controls the primary combustion air to the gas burner and is preset at the factory for natural gas fuel. Some adjustment may be necessary to obtain desired flame and to eliminate carbon deposits. Evaluate flame appearance after the fireplace has reached operating temperature. See Fig. #24 for proper flame pattern.

Open primary air shutter if the logs, glass, and firebox have carbon accumulation and / or the flames are long, dark and stringy. The shutter may also be opened to enhance the Ember Material glow and lessen the flame height.

For Propane, start with the air shutter fully open and adjust to decrease air if needed.

Caution: Burner area may be hot!

Turn off the fireplace and allow the unit to cool before proceeding.

Caution: Proper air shutter setting is a must.

The flame should be just orange and "lazy". It should NEVER be set to create sooting on internal parts and glass.

To Adjust:

1. Open and remove window frame and set aside. See "Window Frame Removal" section found in the Installation and Operating Instructions manual.
2. Remove the log set and set aside.
3. Loosen the screw in the Primary Air Shutter.
4. Rotate the shutter to increase or decrease the amount of primary air. Fully closed for natural gas and fully open for propane gas.
5. Reassemble in reverse order.

Fig. # 24



Fig. # 25



Replacement Parts

(WHEN ORDERING, INCLUDE PART NUMBER WITH DESCRIPTION)

ITEM.....DESCRIPTION.....	PART NO.
#1.....HEARTWOOD BURNER ASSEMBLY.....	22150009
#2.....HEARTWOOD LOG SET.....	5094.302318
#3.....ORIFICE, NATURAL GAS (#32).....	5021.332A

ITEM.....DESCRIPTION.....	PART NO.
#4.....PILOT ASSEMBLY.....	TCRP.5005025
#5.....MAIN SUPPLY TUBE (FLEX).....	5019.223
*#6.....PROPANE CONVERSION KIT.....	TC30.DLPKIT

***NOT SHOWN**

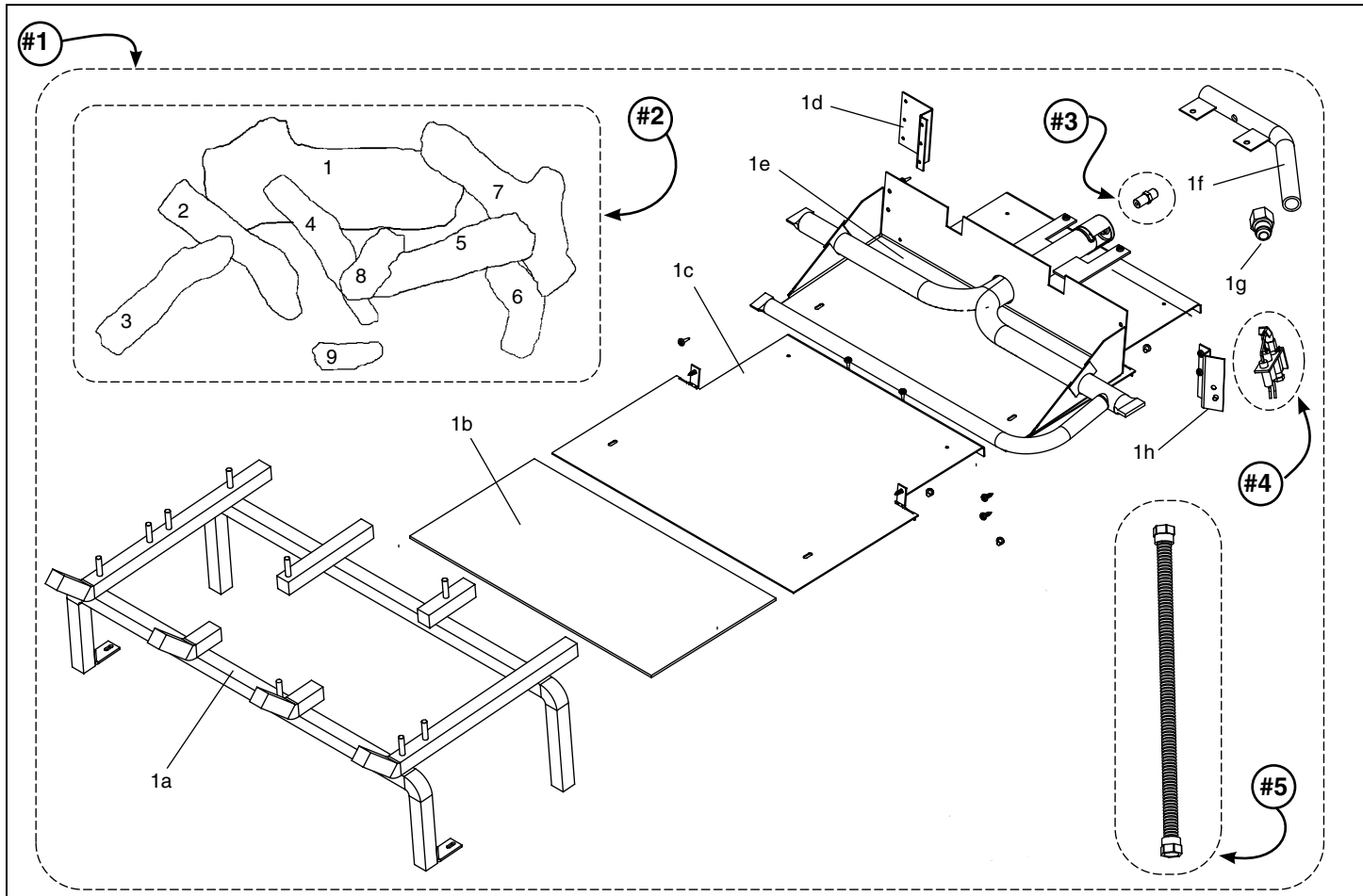

KIT CONTENTS:

- | | | |
|--|---|--|
| <p>#1.... BURNER ASSEMBLY</p> <ul style="list-style-type: none"> 1a GRATE 1b BURNER INSULATION 1c BURNER TRAY SUPPORT SHIELD 1d PILOT SHIELD 1e TC36.NG01 BURNER WELD 1f MANIFOLD 1g 1/2 PIPE TO 1/2 TUBE CONNECTION 1h PILOT BRACKET | <p>#2.... 9 PCS HEARTWOODLOG SET</p> <ul style="list-style-type: none"> EMBER MATERIAL (Not shown) 1 BASE LOG 2 LEFT CENTER LOG 3 LEFT FRONT LOG 4 LOG WITH HOLE 5 RIGHT CENTER LOG 6 FRONT RIGHT LOG 7 RIGHT BASE LOG 8 CENTER TWIG 9 CENTER BASE CHUNK | <p>#3.... ORIFICE, NATURAL GAS (#32)</p> <p>#4.... PILOT ASSEMBLY, CONVERTIBLE (INCLUDING TUBE)</p> <p>#5.... MAIN SUPPLY TUBE (FLEX)</p> <p>#6.... PROPANE CONVERSION KIT (Not shown)</p> |
|--|---|--|



© 2016 Copyright Pacific Energy Fireplace Products LTD

Reproduction, adaptation, or translation
without prior written permission is prohibited,
except as allowed under the copyright laws.



For technical support, please contact your retailer.

**www.townandcountryfireplaces.net
2975 Allenby Rd., Duncan, BC V9L 6V8**