

**INSTALLER: Leave this manual with the appliance.
CONSUMER: Retain this manual for future reference.**

These instructions are supplementary to the Installation and Operating Instructions supplied with the fireplace and should be kept together. Refer to the Installation and Operating Instructions for proper gas supply, safety requirements and operating instructions.

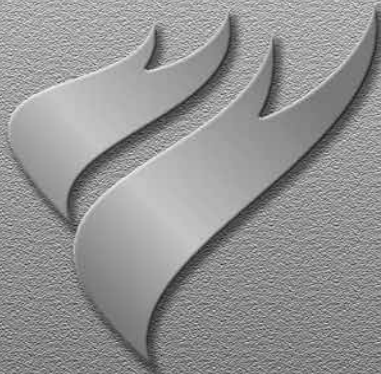

TOWN & COUNTRY
L U X U R Y F I R E P L A C E S

TC36ST SEE-THRU CHALET BURNER KIT INSTRUCTIONS



**PART# 22150055
For TC36ST SEE-THRU
FIREPLACES
Series D/D2**



Package Contents

- BURNER/GRATE ASSEMBLY
- 11 PCS LOG SET
- PILOT ASSEMBLY
- GAS FLEX LINE
- 2 EMBER MATERIAL
- HARDWARE PACKAGE



Burner/Grate Installation

In these instructions the right and left sides of the fireplace are referenced during the installation process. The right side of the unit has the control access cover in it.

1. Attach the burner/grate assembly to the floor of the firebox with four screws.(Fig. # 1)
2. Connect the flex hoses from the pilot and the main burner supply to the bulkhead fittings on the firebox. (Fig. # 2)
3. Connect the electrical connections from the pilot assembly to the connections in the firebox side. Ensure that the wire with the RED END is connected to the rear of the two connectors (marked with colored dot) in the bulkhead, as viewed with control pn right side. (Fig. # 3)

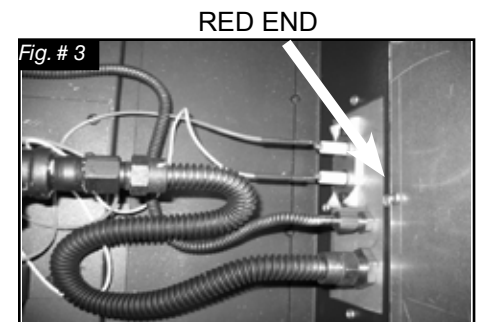
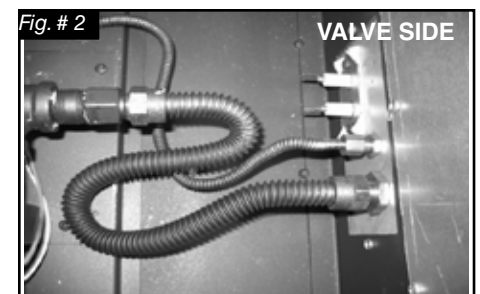

A panel set must now be installed. See Installation and Operating Instructions manual for details.

Propane Conversion

If the unit is to be used on propane, convert as follows using the components supplied with this fireplace:

WARNING

This conversion kit shall be installed by a qualified service agency in accordance with the manufacturer's instructions and all applicable codes and requirements of the authority having jurisdiction. If the information in these instructions is not followed exactly, a fire, explosion or production of carbon monoxide may result causing property damage, personal injury or loss of life. The qualified service agency is responsible for the proper installation of this kit. The installation is not proper and complete until the operation of the converted appliance is checked as specified in the manufacturer's instructions supplied with the kit.

CAUTION

The gas supply and electrical power shall be shut off before proceeding with the conversion.

Note: Factory supplied components must be used to ensure correct input.
After conversion confirm proper manifold pressure.

1. Ensure the burner, pilot and gas supply are turned off, and the appliance has cooled.
2. Note log positions and carefully remove them (if installed).
3. Remove the log grate.
4. (Continued on next page)

4. Remove the 2 front screws holding the burner tray in place and slide tray sideways to access burner orifice. (Fig. #4)

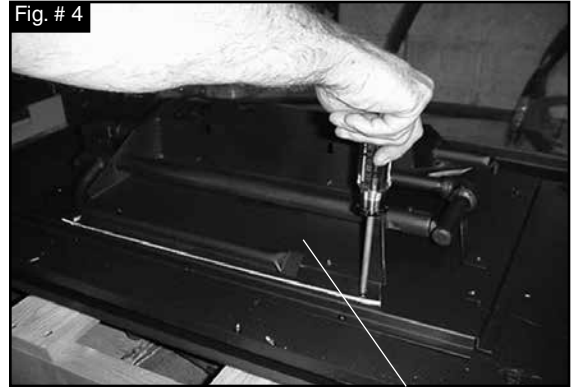

Burner Tray Assembly

5. Using a 1/2" wrench, undo the natural gas burner orifice, (marked #32). (Fig. #5)

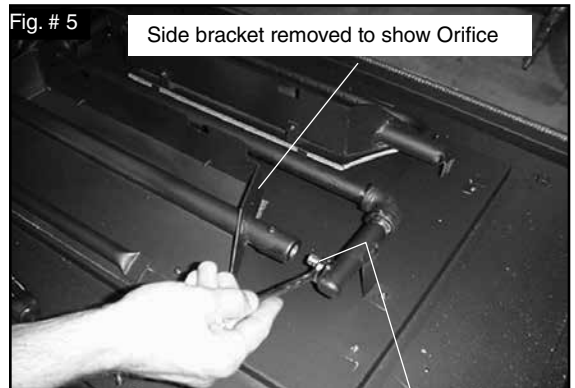

Burner Orifice

6. Apply a small amount of pipe joint compound to the threads of the propane burner orifice (marked 1.8 mm) to ensure a good seal, before screwing it into the fitting.

7. Repeat procedures 4, 5 & 6 for the other side.

8. Reposition the manifold assembly and fasten in place with screws previously removed.

9. Open primary air shutters fully.

10. Replace the log grate.

11. With a 7/16" wrench loosen the pilot head on the pilot assembly (Fig. #6)

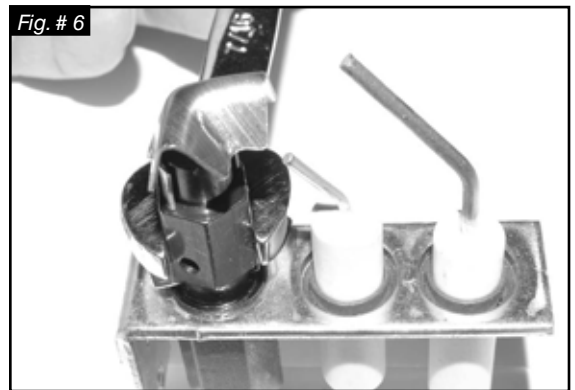

12. Slide the pilot adjustment band over and ensure that the hole in the orifice band is showing. (Fig. #7 indicates NG position, Fig. #8 indicates LP position)

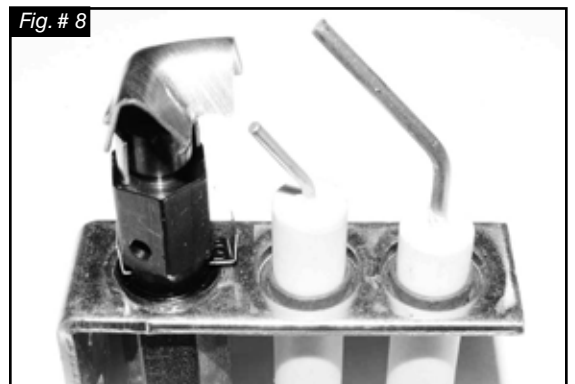
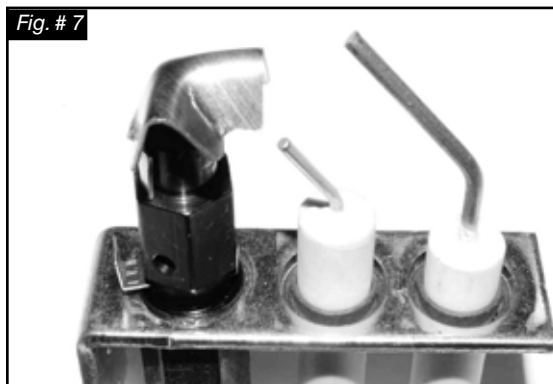

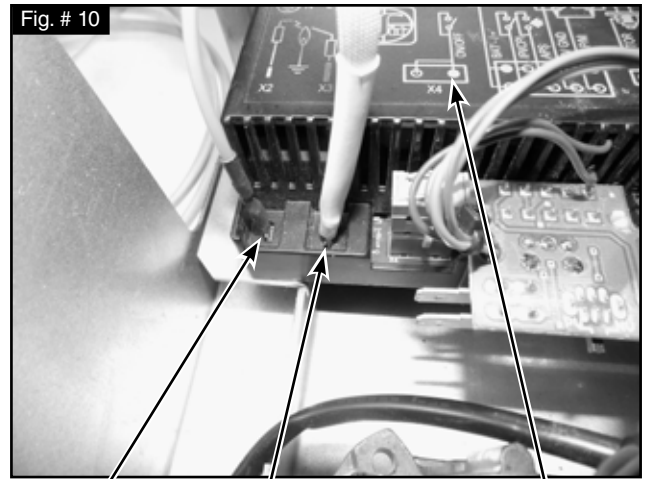
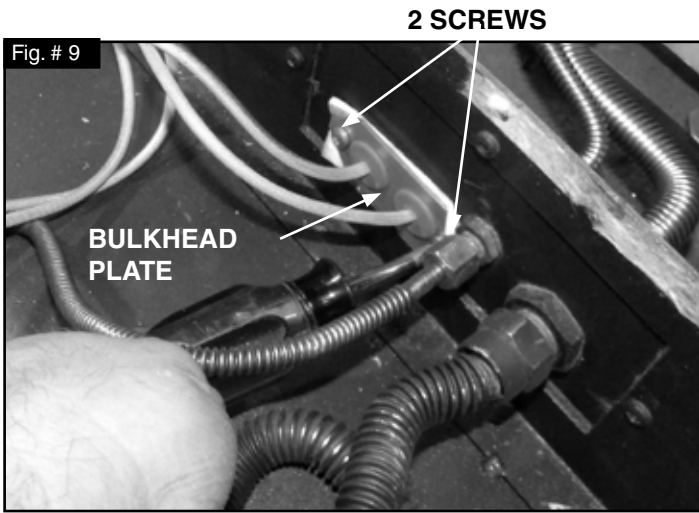

IGNITION WIRE (RED) FLAME SENSOR WIRE (WHITE) INTERFACE MODULE

13. Secure the electrical bulkhead plate (Fig.#9) and gasket to the firebox. (2 screws) Attach the ignition and sensor wires to the module. (Fig.#10).

14. Fill in the date and the name of the person who performed the conversion in the grey areas on the conversion label (Fig #11). Peel off the protective backing and apply the conversion label directly over the gas specifications on the rating label.

15. Attach the access panel to the side of the firebox with the previously removed screws. (Fig. #12)

Note: Gasket must be installed with access panel.

Fig. # 11

This appliance was converted to propane gas	
Kit Number	PACIFIC ENERGY
dd / mm / yy	5052.52001-B
Company	conversion a été correctement faite.
Address	responsabilité que cette
The above accepts the responsibility that this conversion has been properly performed.	ci-dessus accepte la
	l'entreprise désignée
	Adresse
	Firme
	j / m / a
5052.52001-B	Numéro d'assemblage
PACIFIC ENERGY	
Cet appareil a été converti en gaz propane	

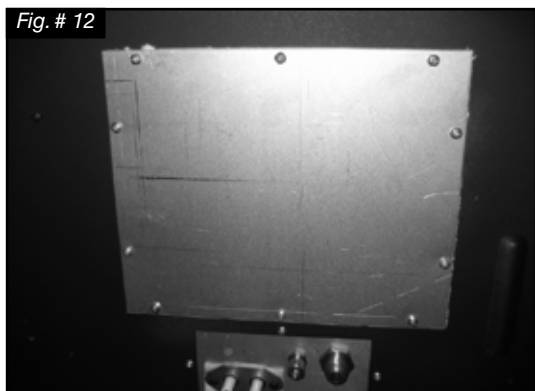

For complete valve installation instructions, refer to the instruction book included in the SIT conversion kit.

Gas Pressure Check

Note: To test the gas pressure, turn off the gas supply before removing the blanking plug from the supply pressure test port or manifold pressure test port. Verify gas pressures with the fireplace lit and on the highest setting.

1. Remove the blanking plug from the pressure test port. The plug is located between the right side lintel and firebox side. (Fig. # 13)

CORRECT GAS PRESSURE REQUIREMENT:

Supply Pressure

(For purpose of input adjustment)

	Natural Gas	Propane
Minimum	5.0" wc	12.5" wc
Maximum	13.9" wc	13.9" wc

Manifold Pressure

Maximum	3.5" wc	10.0" wc
Minimum	1.6" wc	6.4" wc



2. Thread the extension test fitting into the open test port. (Fig. # 14)
3. Attach a pressure gauge onto the fitting.
4. When testing is complete, shut off the gas, remove the fitting and replace the blanking plug. Thread sealant will be required to ensure a gas tight connection.



Ember Material

Two large bags of ember material are shipped with the fireplace and need to be installed to ensure optimum performance and flame appearance.

Pull apart the material into ember size pieces (approximately 1" squares) and gently place them into the burner pan. Do not compress, leave it loose for best performance. Fill the burner pan level with the top of the pan at rear, and gradually slope forward down to the firebox floor at the front, covering both burner tubes. Place remaining ember material outside of the burner pan as desired to cover-up gas lines and brackets.

Note: Ember material placement and amount will affect flame appearance. More ember material results in lower flame height. Add or remove as needed until desired flame affect. Reduce the amount used on Propane models, as too much will create soot.

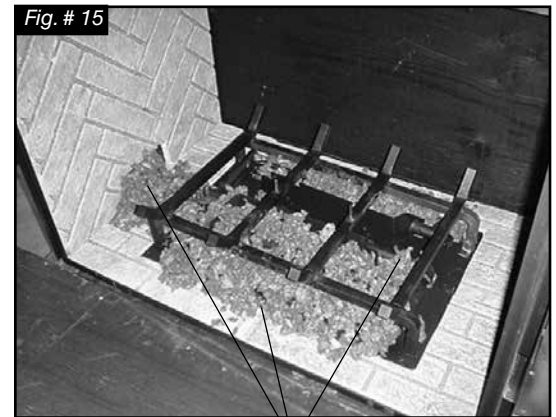

GLOWING EMBERS

Log Set Assembly

The logs are packaged in a foam pack inside the box and are fragile, and should be handled with care. Unpack and inspect log set. There should be a total of 11 logs. Gas plumbing and vent connections should be completed before proceeding. Position the logs as indicated by the following pictures.

Step 1

CENTER LOG PLACEMENT

1. Align the center log with the pins located at the center of the grate

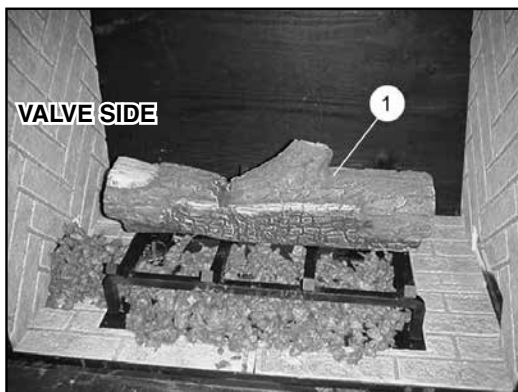

Step 2

RIGHT LOG PLACEMENT

2. Place right log as pictured.

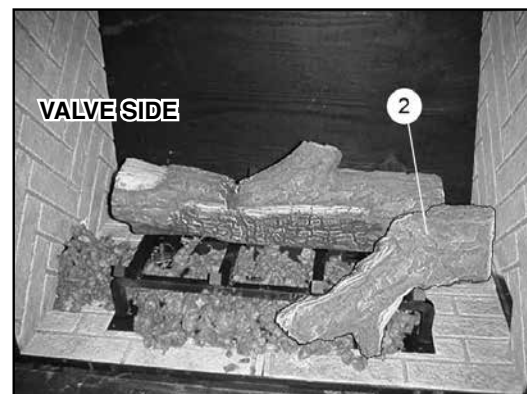

Step 3

LEFT LOG PLACEMENT

3. Install the left log onto the grate straddling the grate as shown.

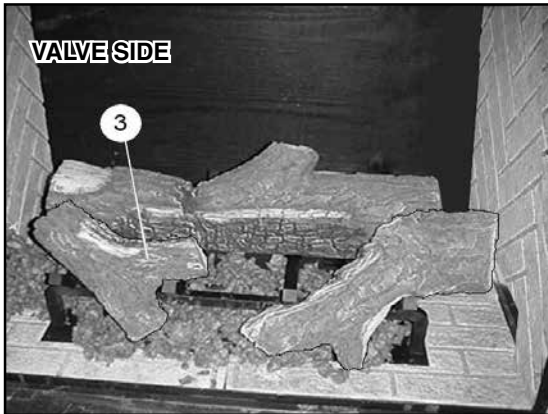

Step 4

LEFT END LOG PLACEMENT

4. Install the left end log on the floor near the left leg of the grate as shown.



Step 5

RIGHT END LOG PLACEMENT

5. Place the right end log near the right leg of the grate as shown.

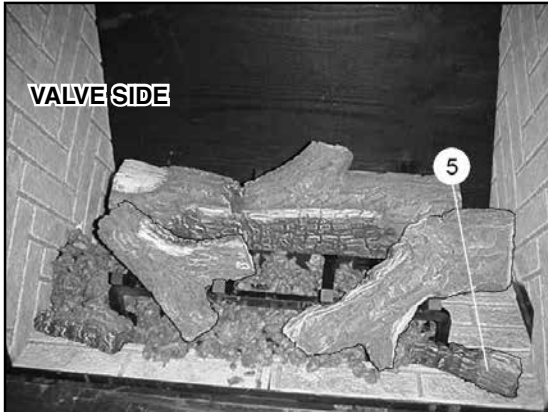

Step 6

CENTER FLOOR LOG PLACEMENT

6. Place the center floor log over the joint in the floor panels as shown.

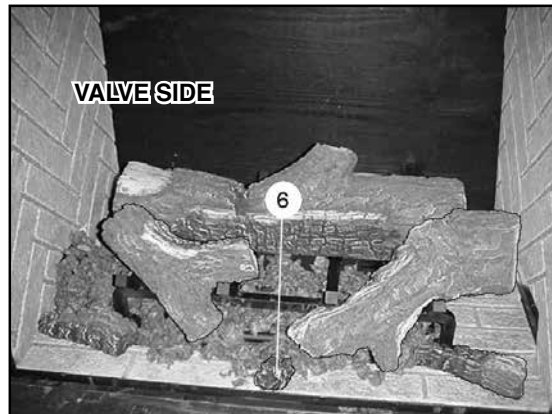

LOG PLACEMENT, VIEW FROM OTHER SIDE



Repeat the procedure for the remaining logs on the other side of the unit. See Steps 1 – 11

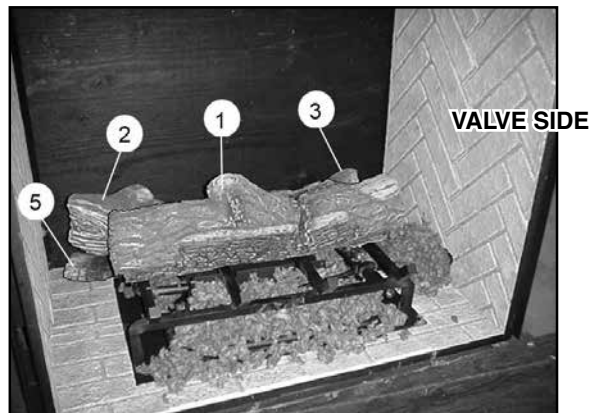

Step 7

RIGHT LOG PLACEMENT

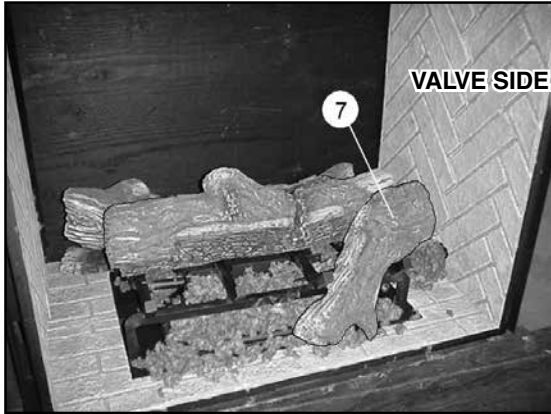

Step 8

LEFT LOG PLACEMENT

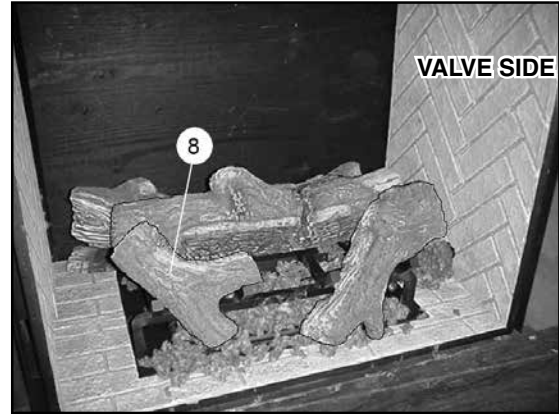

Step 9

LEFT END LOG PLACEMENT

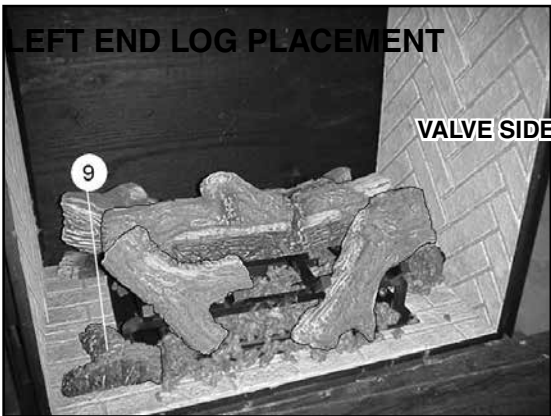

Step 10

RIGHT END LEFT LOG PLACEMENT

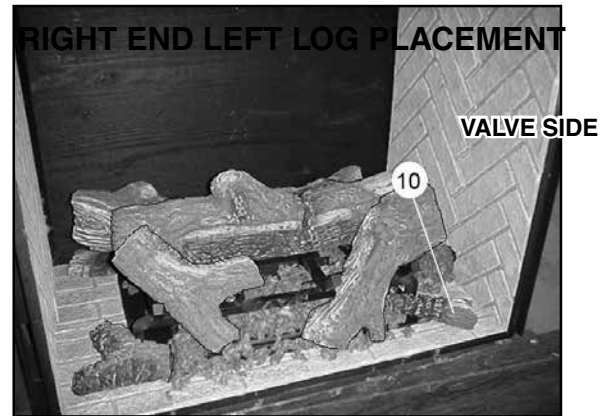

Step 11

CENTER FLOOR LOG PLACEMENT

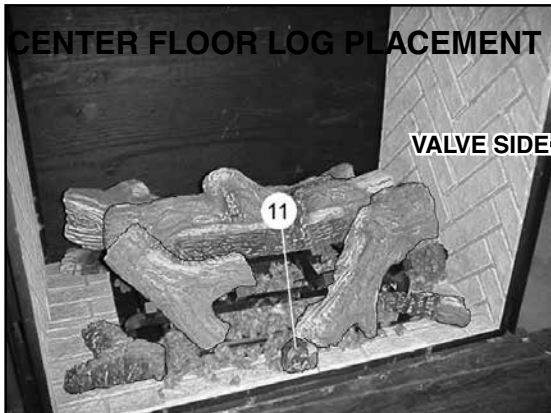

Note: Improper placement of logs will create soot on internal parts and glass.

Burner Flame Adjustment

The air shutter on the burner tube controls the primary combustion air to the gas burner and is pre-set closed at the factory for natural gas fuel. Some adjustment may be necessary to obtain desired flame and to eliminate carbon deposits. Evaluate flame appearance after the fireplace has reached operating temperature. See Fig. #17 for proper flame pattern.

Open primary air if the logs, glass, and firebox have carbon accumulation and/or the flames are long, dark and stringy. The shutter may also be opened to enhance the Ember Material glow and lessen the flame height.

Caution: Burner area may be hot!

Turn off the fireplace and allow the unit to cool before proceeding.

To Adjust: (See Fig. # 16)

1. Open and remove window frame and set aside. See "Window Frame Removal" section found in the Installation and Operating Instructions manual.
2. Remove the log set and set aside.
3. Loosen the screw in the Primary Air Shutter.
4. Rotate the shutter to increase or decrease the amount of primary air.

Caution: Proper air shutter setting is a must.

The flame should be just orange and "lazy." It should NEVER be set to create sooting on internal parts and glass.

PRIMARY AIR SHUTTERS

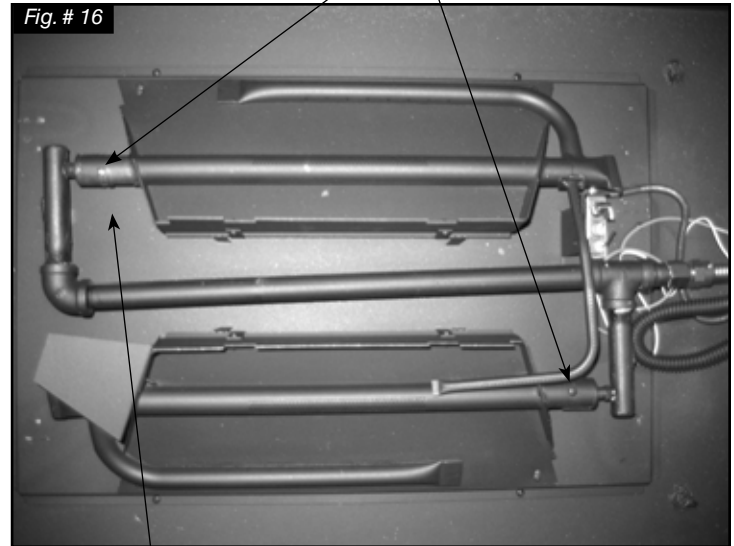

*SIDE BRACKET HAS BEEN REMOVED TO SHOW SHUTTER



HERRINGBONE PANEL SET SHOWN

Replacement Parts

ITEM.....DESCRIPTION.....PART NO.

ITEM..... DESCRIPTIONPART NO.

- 1..... LOG GRATE..... TC36.9381WELD
- 2..... BURNER TRAY SUPPORT SHIELD..... 9369.001
- 3..... BURNER TRAY, FR..... TC36.9370FWELD
- 4..... SIDE BRACKET, FR..... 9370.6
- * 5..... MANIFOLD ASM..... TC36.93711
- 6..... SIDE BRACKET, RR..... 9370.51
- 7..... BURNER TRAY, RR..... TC36.9370RWELD
- 8..... LIGHTER TUBE..... TC36.5011841WLD
- 9..... MANIFOLD FITTING..... 5019.221
- 10..... ORIFICE, NG..... 5021.332.A
- ORIFICE, LP..... 5022.85
- * 11..... PILOT BRACKET..... 9372.5
- 12..... FIREBOX HEAT SHIELD..... 9389.02
- 13..... HEAT SHIELD GASKET..... 9389.5

- 14... 1/4" FLEX COMPRESSION..... 5019.225
- 15... 1/2" FLEX FLARE CONNECTION..... 5019.223
- 16... PILOT ASSEMBLY..... TCRP.5005025
- LOG SET, COMPLETE.....5094.36ST2321
- CENTER, #1 (shown in fig.#5)
- MIDDLE RIGHT, #2 (shown in fig.#6)
- * MIDDLE LEFT, #3 (shown in fig.#6)
- FRONT LEFT, #4 (shown in fig.#6)
- FRONT RIGHT, #5 (shown in fig.#7)
- FRONT CENTRE, #6 (shown in fig.#7)

* NOT SOLD SEPARATELY

Fig. # 18

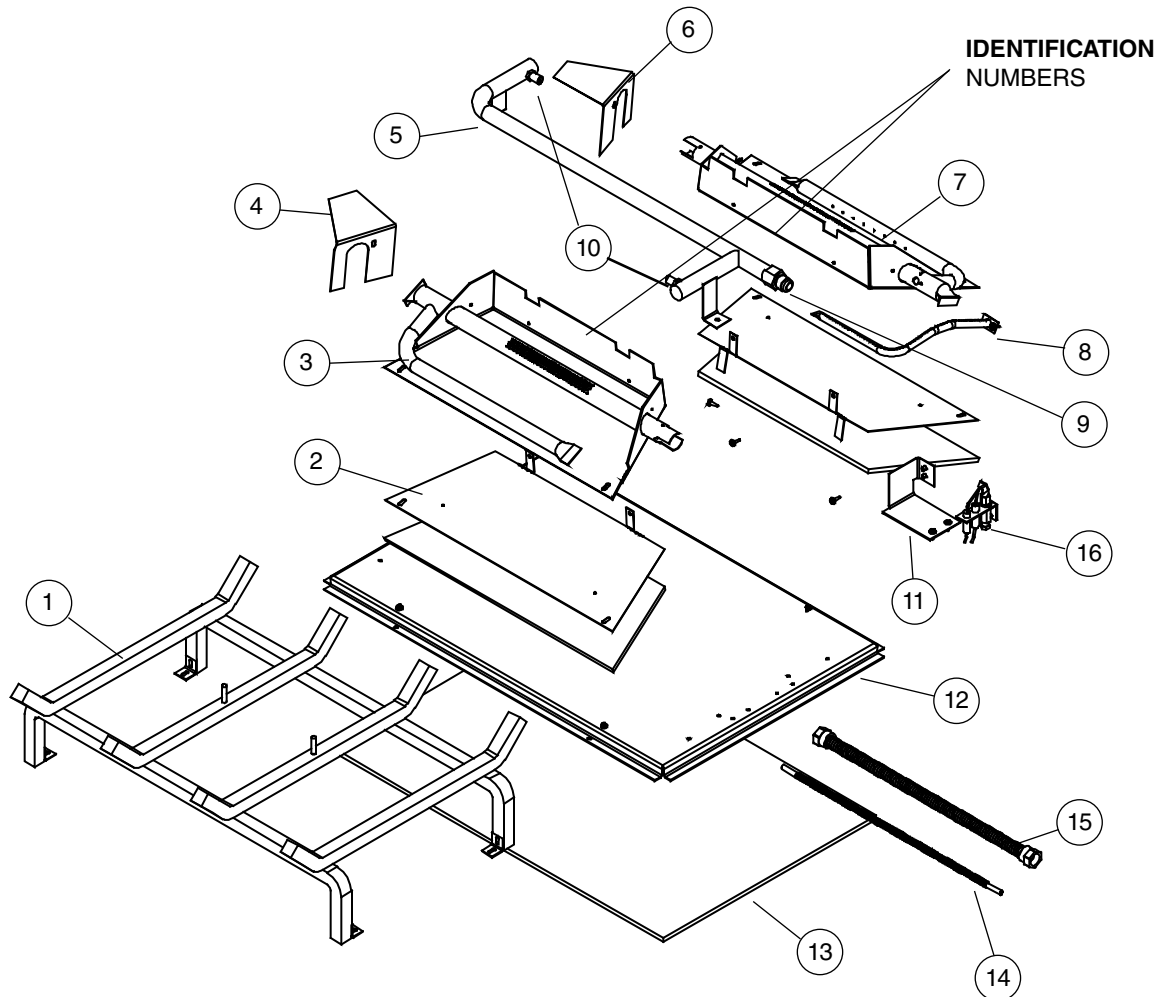

Reproduction, adaptation, or translation
without prior written permission is prohibited,
except as allowed under the copyright laws.



TOWN & COUNTRY

L U X U R Y F I R E P L A C E S

For technical support, please contact your retailer.

www.townandcountryfireplaces.net
2975 Allenby Rd., Duncan, BC V9L 6V8